



SF SERIES EXPLOSION-PROOF PUMPS

INSTALLATION OPERATION AND MAINTENANCE

GORMAN-RUPP PUMPS

www.grpumps.com

Register your new
Gorman-Rupp pump online at
www.grpumps.com

Valid serial number and e-mail address required.

RECORD YOUR PUMP MODEL AND SERIAL NUMBER

Please record your pump model and serial number in the spaces provided below. Your Gorman-Rupp distributor needs this information when you require parts or service.

Pump Model: _____
Serial Number: _____

TABLE OF CONTENTS

INTRODUCTION	PAGE I – 1
SAFETY - SECTION A	PAGE A – 1
INSTALLATION – SECTION B	PAGE B – 1
GENERAL INFORMATION	PAGE B – 1
PREINSTALLATION INSPECTION	PAGE B – 1
LUBRICATION	PAGE B – 1
PUMP MOTOR SPECIFICATIONS	PAGE B – 1
PUMP INSTALLATION	PAGE B – 2
Lifting	PAGE B – 2
Impeller Rotation	PAGE B – 3
Positioning the Pump (Guide Rail Application)	PAGE B – 3
Positioning the Pump (Stand Application)	PAGE B – 3
Piping	PAGE B – 3
ELECTRICAL CONNECTIONS	PAGE B – 4
Field Wiring Connections (Incoming Power)	PAGE B – 4
Dual Voltage	PAGE B – 4
Motor Cable Grounding Test	PAGE B – 4
Control Box Connections	PAGE B – 5
Liquid Level Devices	PAGE B – 6
OPERATION – SECTION C	PAGE C – 1
GENERAL INFORMATION	PAGE C – 1
Pump Performance	PAGE C – 1
Control Box	PAGE C – 1
PUMP OPERATION	PAGE C – 1
Liquid Temperature And Overheating	PAGE C – 1
STARTING, STOPPING AND OPERATIONAL CHECKS	PAGE C – 2
Starting	PAGE C – 2
Stopping	PAGE C – 2
Operational Checks	PAGE C – 2
COLD WEATHER PRESERVATION	PAGE C – 3
LUBRICATION	PAGE C – 3
Draining Oil	PAGE C – 3
Condition of Oil	PAGE C – 3
Adding Oil	PAGE C – 3
TROUBLESHOOTING – SECTION D	PAGE D – 1
ELECTRICAL TESTING	PAGE D – 3
Test Equipment	PAGE D – 3
Voltage Imbalance	PAGE D – 3
Motor and Power Cable Continuity	PAGE D – 3
Insulation Resistance	PAGE D – 4

TABLE OF CONTENTS
(continued)

PUMP MAINTENANCE AND REPAIR - SECTION E	PAGE E – 1
GENERAL INFORMATION	PAGE E – 1
Lifting	PAGE E – 1
PARTS LISTS:	
Pump Model SF4A–X	PAGE E – 3
PUMP END DISASSEMBLY AND REASSEMBLY	PAGE E – 4
PUMP END DISASSEMBLY	PAGE E – 5
Preparing Pump for Disassembly	PAGE E – 5
Suction Head and Wear Ring Removal	PAGE E – 5
Pump Casing Removal	PAGE E – 5
Draining Oil From Seal Cavity	PAGE E – 5
Impeller Removal	PAGE E – 5
Seal Removal	PAGE E – 6
PUMP END REASSEMBLY	PAGE E – 6
Hardware Torque Values	PAGE E – 6
Cleaning and Inspection of Pump Parts	PAGE E – 6
Seal Installation	PAGE E – 7
Impeller Installation	PAGE E – 8
Suction Head and Wear Ring Installation	PAGE E – 8
Pump Casing Installation	PAGE E – 9
Impeller Face Clearance Adjustment	PAGE E – 9
Final Assembly	PAGE E – 9
LUBRICATION	PAGE E – 9
Seal Cavity	PAGE E – 9

INTRODUCTION

Thank You for purchasing a Gorman-Rupp SF Series explosion-proof pump. **Read this manual** carefully to learn how to safely install and operate your pump. Failure to do so could result in personal injury or damage to the pump.

This manual contains essential information on installing and operating the pump, and on making electrical connections. However, since pump installations are seldom identical, some of the information only summarizes general recommendations and practices required to inspect, position, and arrange the pump and piping.

This manual provides troubleshooting and maintenance instructions required to properly diagnose operational problems, and to service the pump hydraulic components only. Pump motor maintenance may be performed **only** by a Gorman-Rupp authorized repair facility, or the factory. Otherwise, the pump warranty will be negated, and damage to the pump, and injury or death to personnel can result. Contact the factory for the authorized repair facility closest to you.

The motor powering this pump is approved by either CSA and/or FM for Class 1, Division 1, Groups C and D environments. Refer to the nameplate on your pump for agency approval information. All repairs to the pump, other than seal, impeller and other hydraulic components, **must** be performed by a Gorman-Rupp authorized repair facility or the factory. Any repairs to the motor assembly performed by the customer or an unauthorized repair facility negates the agency approval and the motor warranty, and damage to the pump, and injury or death to personnel can result. If the motor is dual-voltage, the pump is shipped from the factory wired **only** for the voltage shown on the nameplate. If desired to have the voltage changed, return the pump to the factory or to a Gorman-Rupp authorized repair facility.

The pump motor **must** be operated through an appropriate control box matching the voltage and other characteristics of the motor. The control box must provide for proper operation of the motor protection devices, such as the integral moisture and thermal switches. Control boxes and other control devices not integral to the pump are **not** covered in this manual.

Pump construction is cast iron, with stainless steel shaft and hardware.

These pumps may be equipped with a guide shoe for mounting on guide rails in a wet well. A guide rail system, controls and liquid level devices are available from the factory as optional equipment.

If there are any questions regarding the pump which are not covered in this manual or in other literature accompanying the unit, please contact your Gorman-Rupp distributor or the Gorman-Rupp Company:

The Gorman-Rupp Company
P.O. Box 1217

Mansfield, Ohio 44901-1217
Phone: (419) 755-1011

or:

Gorman-Rupp of Canada Limited
70 Burwell Road

St. Thomas, Ontario N5P 3R7
Phone: (519) 631-2870

RECORDING MODEL AND SERIAL NUMBERS

Please record the pump model, serial number, voltage, and motor impeller diameter in the spaces provided below. Your Gorman-Rupp distributor needs this information when you require parts or service.

Pump Model: _____

Serial Number: _____

Voltage: _____

Impeller Diameter: _____

WARRANTY INFORMATION

The warranty provided with your pump is part of Gorman-Rupp's support program for customers who operate and maintain their equipment as described in this and the other accompanying literature. Please note that should the equipment be abused or modified to change its performance beyond the original factory specifications, the warranty will become void and any claim will be denied.

HAZARD AND INSTRUCTION DEFINITIONS

The following are used to alert personnel to procedures which require special attention, to those which could damage equipment, and to those which could be dangerous to personnel:



Immediate hazards which WILL result in severe personal injury or death. These instructions describe the procedure required and the injury which will result from failure to follow the procedure.



Hazards or unsafe practices which

COULD result in severe personal injury or death. These instructions describe the procedure required and the injury which could result from failure to follow the procedure.



Hazards or unsafe practices which COULD result in minor personal injury or product or property damage. These instructions describe the requirements and the possible damage which could result from failure to follow the procedure.

NOTE

Instructions to aid in installation, operation, and maintenance or which clarify a procedure.

SAFETY – SECTION A

The following information applies throughout this manual to Gorman-Rupp SF Series explosion-proof submersible pumps.

In addition to this manual, see the separate literature covering the control box, control accessories or other equipment shipped with this pump.

Because pump installations are seldom identical, this manual cannot possibly provide detailed instructions and precautions for each specific application. Therefore, it is the owner/installer's responsibility to ensure that applications not addressed in this manual are performed only after establishing that neither operator safety nor pump integrity are compromised by the installation.



Before attempting to install, operate, or service this pump, familiarize yourself with this manual, and with all other literature shipped with the pump. Unfamiliarity with all aspects of pump operation covered in this manual could lead to destruction of equipment, injury, or death.



The motor powering this pump is approved by either CSA and/or FM for Class 1, Division 1, Groups C and D environments. Refer to the nameplate on your pump for agency approval information. Any liquid level devices used with the pump must be intrinsically safe for use in these environments.

Any control box used to operate the pump must meet all applicable local

and national codes for the application. If the control box is to be installed in an explosive environment, it must be a Nema 7 rating or better. If a non-explosion proof control box is used, it must be located outside the explosive environment. Improper location of a non-explosion proof control box could result in destruction of equipment, injury, or death to personnel.



When installing or servicing the pump or controls, follow all requirements for the installation of wiring or electrical equipment in hazardous locations as outlined in the National Electric Code. When entering the pump wet well for installation or service, follow all safety requirements for confined space entry. Failure to observe these requirements could result in injury or death to personnel.



The electrical power used to operate this pump is high enough to cause injury or death. Obtain the services of a qualified electrician to make all electrical connections.



Do not connect the pump motor directly to the incoming power lines. The pump motor is designed to operate through a Gorman-Rupp approved control box which provides overload protection and power control; otherwise, the pump warranty will be voided. Make certain

that the pump and control box are properly grounded and that the incoming power matches the requirements of the pump and controls. Install and operate the control box in accordance with the National Electric Code and all local codes. Failure to follow the instructions in this warning could result in injury or death to personnel.



This pump is not designed to pump volatile, flammable, or corrosive liquids. The maximum temperature of the liquid being pumped should not exceed 104°F (40°C); do not apply the pump at higher temperatures. Do not attempt to pump any liquids which may damage the pump or endanger personnel as a result of pump failure.



The following precautions should be taken before attempting to open or service the pump; otherwise, injury or death could result.

1. Familiarize yourself with this manual.
2. Lock out incoming power to the control box to ensure that the pump will remain inoperative.
3. Allow the pump to completely cool if overheated.
4. Close the discharge valve (if used).



Death or serious personal injury and damage to the pump or components can occur if proper lifting procedures

are not observed. Make certain that hoists, chains, slings or cables are in good working condition and of sufficient capacity. Do not attempt to lift this pump by the motor or control cables, or the piping. Attach proper lifting equipment to the lifting bail fitted on the pump. Discharge hoses and piping must be removed from the pump before lifting. Lift the pump only as high as necessary and keep personnel away from suspended objects.



This pump was wired at the factory only for the voltage shown on the nameplate. Do not attempt to change the voltage on a dual-voltage motor. If desired to have the voltage changed, return the pump to the factory or to an authorized Gorman-Rupp repair facility only; otherwise, the pump warranty will be negated, and damage to the pump, and injury or death to personnel can result.



The electrical power used to operate this pump is high enough to cause injury or death. Obtain the services of a qualified electrician to make all electrical connections. Make certain that the pump and enclosure are properly grounded; never use gas pipe as an electrical ground. Be sure that the incoming power matches the voltage and phase of the pump and control before connecting the power source. Do not run the pump if the voltage is not within the limits. If the overload unit is tripped during pump operation, correct the problem before restarting the pump.



The electrical power used to operate this pump is high enough to cause injury or death. Make certain that the control handle on the control box is in the OFF position and locked out, or that the power supply to the control box has been otherwise cut off and locked out, before attempting to open or service the pump assembly. Tag electrical circuits to prevent accidental start-up.



Never attempt to alter the length or repair any power cable with a splice. The pump motor and cable must be completely waterproof. Injury or death may result from alterations.



All electrical connections must be in accordance with The National Electric Code and all local codes. If there is a conflict between the instructions provided and N.E.C. Specifications, N.E.C. Specifications shall take precedence. All electrical equipment supplied with this pump was in conformance with N.E.C. requirements in effect on the date of manufacture. Failure to follow applicable specifications, or substitution of electrical parts not supplied or approved by the manufacturer, can result in severe injury or death and void warranty.



After the pump has been installed, make

certain that the pump and all piping or hose connections are secure before operation.



Approach the pump cautiously after it has been running. Although the motor is cooled by dispersing heat through the motor housing cooling fins into the liquid being pumped, normal operating temperatures can still be high enough to cause burns. The temperature will be especially high if operated against a closed discharge valve. Never operate against a closed discharge valve for long periods of time.



Do not remove plates, covers, gauges, pipe plugs, or fittings from an overheated pump. Vapor pressure within the pump can cause parts being disengaged to be ejected with great force. Allow the pump to completely cool before servicing.



If the pump is used to handle liquids which may cause illness or disease through direct exposure, take necessary precautions during maintenance and repair to prevent personal contamination.



The motor powering this pump is approved by either CSA and/or FM for Class 1, Division 1, Groups C and D environments. Refer to the nameplate on your

pump for agency approval information. All repairs to the pump, other than seal, impeller and other hydraulic components, must be performed by a Gorman-Rupp authorized repair facility or the factory. Any repairs to the motor assembly performed by the customer or an unauthorized repair facility negates the agency approval and the motor warranty.



Pumps and related equipment must be installed and operated according to all national, local and industry standards.

INSTALLATION – SECTION B

GENERAL INFORMATION

Review all SAFETY information in Section A.

Since pump installations are seldom identical, this section is intended only to summarize general recommendations and practices required to inspect, position, and arrange the pump and piping. If there are any questions concerning your specific installation, contact your Gorman-Rupp distributor or the Gorman-Rupp Company.



The pump motor is not designed to be operated in air for more than 10 minutes without overheating. The pump must be operated through a liquid level control designed to cut off power when liquid falls below the midpoint of the motor housing (single pump operation), or below the discharge flange (duplex, alternating pump operation).

Controls, liquid level devices, and a guide rail system are available from Gorman-Rupp as optional equipment. For more information on installing and operating these options, refer to the other literature accompanying the option(s).

PREINSTALLATION INSPECTION

The pump assembly was inspected and tested before shipment from the factory. Before installation, check for damage which may have occurred during shipment. Check as follows:

- a. Inspect the pump assembly for cracks, dents, damaged threads, and other obvious damage.
- b. Check for loose attaching hardware. Since gaskets tend to shrink after drying, check for loose hardware at the mating surfaces.
- c. Inspect the power cable for cuts or any other obvious damage.
- d. Check that amperes, phase, voltage and hertz indicated on the name plate match the ratings on the control box and incoming power.
- e. Carefully read all tags, decals, and markings on the pump, and perform all duties indicated.
- f. Check for oil leaks. If there is any indication of an oil leak, see **LUBRICATION** at the end of this manual.

LUBRICATION

These pumps are equipped with two separate mechanical seals.

The seals prevent the liquid being pumped from entering the seal housing cavity from the pump end, and at the same time prevents the oil in the seal housing from leaking into the motor housing. The upper pump seal is lubricated by oil in the seal housing (see **LUBRICATION** at the end of this manual). The lower seal is lubricated by the medium being pumped.

There is no other lubrication required for these pumps.

Pump Motor Specifications

The motor furnished with this pump is an air-filled, 60 Hz., Squirrel Cage, Induction Start model; NEMA Class H Insulation Rated 356°F (180°C), 104°F (40°C) ambient, plus 252°F (140°C) temperature rise. The motor is approved for Class 1, Division 1, Group C and D locations.

See Table B-1 for motor specifications for each motor frame size.

Table B-1. Pump Motor Specifications

G-R Motor Frame	HP	Volts	PH	Hz	RPM	Full Load Amps	Locked Rotor Amps	LR Code	Start kVA	Design	Service Factor
4A	15	208	3	60	1750	46.8	416	L	149.9	A	1.15
4A	15	230	3	60	1750	42.4	376	L	149.8	A	1.15
4A	15	460	3	60	1750	21.2	188	L	149.8	A	1.15
4A	15	575	3	60	1750	17.0	150	L	149.4	A	1.15
4A	20	208	3	60	1750	58.6	416	J	149.9	A	1.15
4A	20	230	3	60	1750	53.0	376	J	149.8	A	1.15
4A	20	460	3	60	1750	26.5	188	J	149.8	A	1.15
4A	20	575	3	60	1750	21.2	150	J	149.4	A	1.15
4A	24	208	3	60	1750	63.4	416	G	149.9	A	1.0
4A	24	230	3	60	1750	61.6	376	G	149.8	A	1.15
4A	24	460	3	60	1750	30.8	188	G	149.8	A	1.15
4A	24	575	3	60	1750	24.6	150	G	149.4	A	1.15
5A	30	460	3	60	1750	36.6	246	H	196.0	B	1.15
5A	30	575	3	60	1750	29.3	197	H	196.2	B	1.15
6A	50	460	3	60	1750	60.0	425	H	338.6	A	1.15
6A	50	575	3	60	1750	48.0	340	H	338.6	A	1.15
7A	75	460	3	60	1750	86.0	542	G	431.8	B	1.15
7A	75	460	3	60	1750	69.0	434	G	432.2	B	1.15

PUMP INSTALLATION



When installing or servicing the pump or controls, follow all requirements for the installation of wiring or electrical equipment in hazardous locations as outlined in the National Electric Code. When entering the pump wet well for installation or service, follow all safety requirements for confined space entry. Failure to observe these requirements could result in injury or death to personnel.



Do not allow the free end of the power cable to enter the liquid being pumped. The free end of the cable **must** be kept dry to prevent liquid from wicking through the cable and into the motor.

NOTE

Refer to the performance curve on the pump Specification Data Sheet when determining the most efficient piping installation. **The recommended maximum submergence depth is 65 feet.**

Lifting



Death or serious personal injury and damage to the pump or components can occur if proper lifting procedures are not observed. Make certain that hoists, chains, slings or cables are in good working condition and of sufficient capacity and that they are positioned so that loads will be balanced and the pump or components will not be damaged when lifting. Do not attempt to lift this pump by the motor or control cables, or the piping. Attach proper lifting equipment to the lifting bail fitted on the pump. Lift the pump or component

only as high as necessary and keep personnel away from suspended objects.

Pump unit weights will vary depending on the pump application. Check the shipping tag on the unit packaging for the actual weight, and use lifting equipment with appropriate capacity. Drain the pump and remove all customer-installed equipment such as discharge hoses or piping before attempting to lift existing, installed units.

Impeller Rotation

Check impeller rotation as follows before installing the pump on rails or in a wet well.



While checking impeller rotation, secure the pump to prevent the motor power cable from coiling.

Suspend the pump by the lifting handle. Apply power briefly and note the direction of pump kick-back. As viewed from the top, the pump should kick in a **counterclockwise** direction; this will indicate that impeller rotation is correct.

If the pump kicks in a **clockwise** direction, impeller rotation is incorrect. If the pump is powered by a three-phase motor, have a qualified electrician interchange the control box connections of any two pump motor power leads. Re-check pump kick-back; it should now be in a counterclockwise direction.

If rotation is incorrect on a single-phase motor, contact the factory before installing the pump.

Positioning the Pump (Guide Rail Application)



If the pump is to be installed where flammable vapors may be present, the guide rail system must be of a non-sparking design suitable for explosion-proof service. Failure to observe this requirement could result in injury or death to personnel.

The pump may be equipped with a guide shoe for mounting on optional guide rails. A discharge elbow/baseplate is also available as optional equipment.

Use a suitable lifting device attached to the lifting handle to lift the pump. Engage the guide shoe at the top of the guide rails, and lower the pump into the sump. When lowered into place, the guide shoe connects to the optional discharge elbow/baseplate, and the pump is automatically and securely sealed to the piping system; the pump can be removed or installed without personnel entering the wet well.

For information on installing the guide rails, see the literature accompanying the rails. Be sure the installation allows the pump to slide without binding on the rails or baseplate.

NOTE

When engaging the guide shoe and elbow/baseplate, make sure that the connection is not impeded by mounting hardware, and that the guide shoe is fully seated in the baseplate.

Reel in any slack control cable so that it is not dragged into the pump suction.

Positioning the Pump (Stand Application)

Secure a discharge hose to the pump discharge connection, and use a suitable lifting device attached to the lifting handle to lower the pump into the wet well. **The recommended maximum submergence depth is 65 feet.**

Make certain that the pump and stand sit level in the wet well.

Reel in any slack control cable so that it is not dragged into the pump suction.

Piping

The optional discharge elbow/baseplate is drilled for connection to a discharge flange for slide rail applications. Either hose or rigid pipe may be used to make discharge connections.

If rigid discharge piping is installed, the line must be independently supported to avoid vibration and strain on the pump. For maximum pumping capacity, keep the line as short and straight as possible. Elbows and fittings used in discharge lines increase friction loss; minimize their use.

It is recommended that a check valve or throttling valve be installed in the discharge line to control siphoning or back flow when the pump is shut off.

ELECTRICAL CONNECTIONS



Install and operate this pump in accordance with the National Electrical Code and all local codes. Have a qualified electrician perform all checks and connections in this section.

Never attempt to alter the length of the pump motor cable or to repair it with a splice. The power cable and pump motor must be kept completely waterproof. Serious damage to the pump and injury or death to personnel can result from any alteration to the cable.

Field Wiring Connections (Incoming Power)



Do not connect the pump motor directly to the incoming power lines. The pump motor is designed to operate through a control box which provides overload protection and power control; otherwise, the pump warranty will be voided. Make certain that the pump and control box are properly grounded, and that the incoming power matches the requirements of the pump and controls. Install and operate the control box in accordance with the National Electric Code and all local codes. Failure to follow these could result in injury or death to personnel.

Field wiring is **not** provided with this pump, and must be supplied by the user. The field wiring must be of the proper size and type to ensure an adequate voltage supply to the pump. Voltage available **at the motor** must be within the range indicated in Table B-2.

Table B-2. Pump Voltage Requirements

NOMINAL VOLTAGE	PHASE	MINIMUM VOLTAGE	MAXIMUM VOLTAGE
208	3	187	229
230	3	207	253
460	3	414	506
575	3	517	632

Use conduit cable clamps to secure the incoming field wiring to the control box. Make certain all connections are tight. If necessary, support the cable weight to prevent excessive strain on cable clamps and cable.

Refer to the wiring diagrams at the end of this section for field wiring connections.

Dual Voltage



This pump was wired at the factory only for the voltage shown on the nameplate. Do not attempt to change the voltage on a dual-voltage motor. If desired to have the voltage changed, return the pump to the factory or to an authorized Gorman-Rupp repair facility only; otherwise, the pump warranty will be negated, and damage to the pump, and injury or death to personnel can result.

Motor Cable Grounding Test



Do not connect the pump control cable to the control box or incoming voltage before verifying the pump ground; otherwise, personnel will be exposed to serious injury or death.

Connect one lead of a lamp, bell or similar testing device to the motor cable green/yellow ground lead (s). Connect the second test lead to an **uninsulated** point on the pump body. The test circuit should close.

If the test circuit does not close, there is a defect in the cable or motor which must be corrected.

Control Box Connections



The motor powering this pump is approved by both CSA and FM for Class 1, Division 1, Groups C and D environments. Any liquid level devices used with the pump must be intrinsically safe for use in these environments.

Any control box used to operate the pump must meet all applicable local and national codes for the application. If the control box is to be installed in an explosive environment, it must be a Nema 7 rating or better. If a non-explosion proof control box is used, it must be located outside the explosive environment. Improper location of a non-explosion proof control box could result in destruction of equipment, injury, or death to personnel.

This pump is shipped completely wired for the voltage shown on the nameplate and is ready for operation through an approved control box.

Ground the control box in accordance with the instructions accompanying it.

Ground the pump to the control box using the power cable ground(s) and ground check wire (if so equipped). Secure the ground wire(s) and ground check wire (if so equipped) to the grounding lug(s) inside the control box to ensure a thorough ground for the pump.



Ground the pump using the power cable ground wire(s) before applying line potential. Failure to properly ground the pump could result in damage to the pump or control and/or injury or death to personnel.

Refer to Figure B-1 and connect the pump motor cable to the control box.

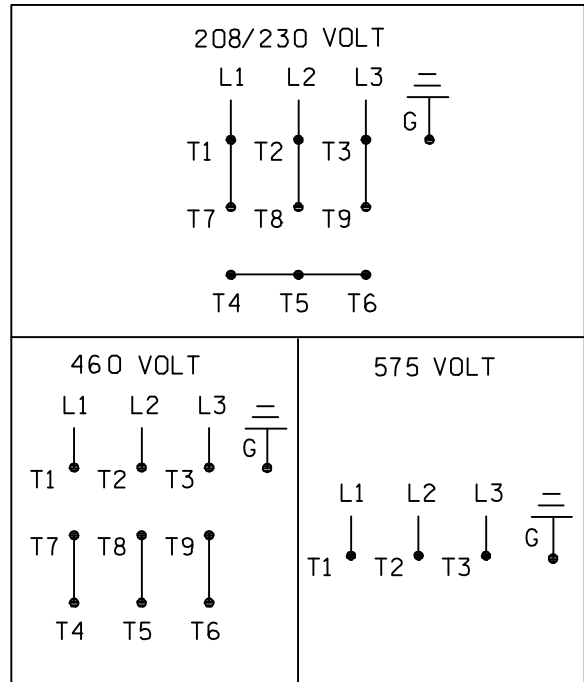

Figure B-1. Three Phase Power Cable Connections

Control leads P1 and P2 provide the motor with thermal protection. Control leads W1 and W2 provide the motor with moisture protection. Refer to Figure B-2 and connect the pump control cable to the control box.

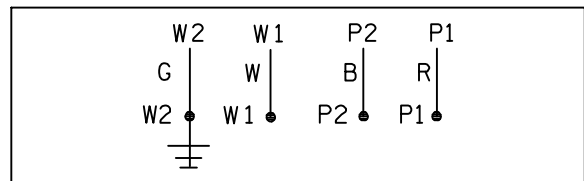
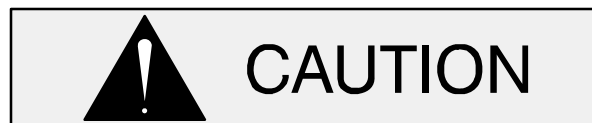

Figure B-2. Control Cable Connections



The thermal protection contacts will automatically re-close when the motor cools to the established safe operating temperature. Whenever automatic restarting is not desirable, connect only to controls which are wired for manual restart.

Refer to the appropriate wiring diagram accompanying the control box when making electrical connections.

Liquid Level Devices

Optional controls available from Gorman-Rupp may provide a means to automatically regulate the liquid level. These control boxes may be connected to the following sensing devices which perform **either** filling or dewatering functions (see Figure B-3).

- **Diaphragm Type:** two fixed-position sensors (upper and lower) each contain a diaphragm which flexes with changes in liquid level, thus activating an enclosed miniature switch.
- **Bulb (Float) Type:** a bulb raises or lowers (floats) with the liquid level, thus activating an enclosed miniature switch.

Other types of liquid level devices may also be used. Consult the factory for the liquid level device best suited for your application.



The internal wiring of the sensing devices are different for filling and dewatering functions. Be sure to follow the instructions included with the option before making connections.

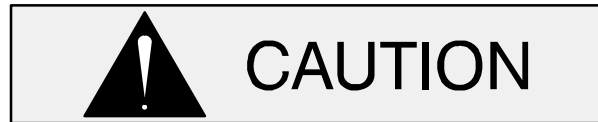

Liquid level devices **must** be positioned far enough to allow 6 minutes between starts. If the pump motor cycles more than 10 starts per hour, it will over-heat, resulting in damage to the motor windings or control box components.

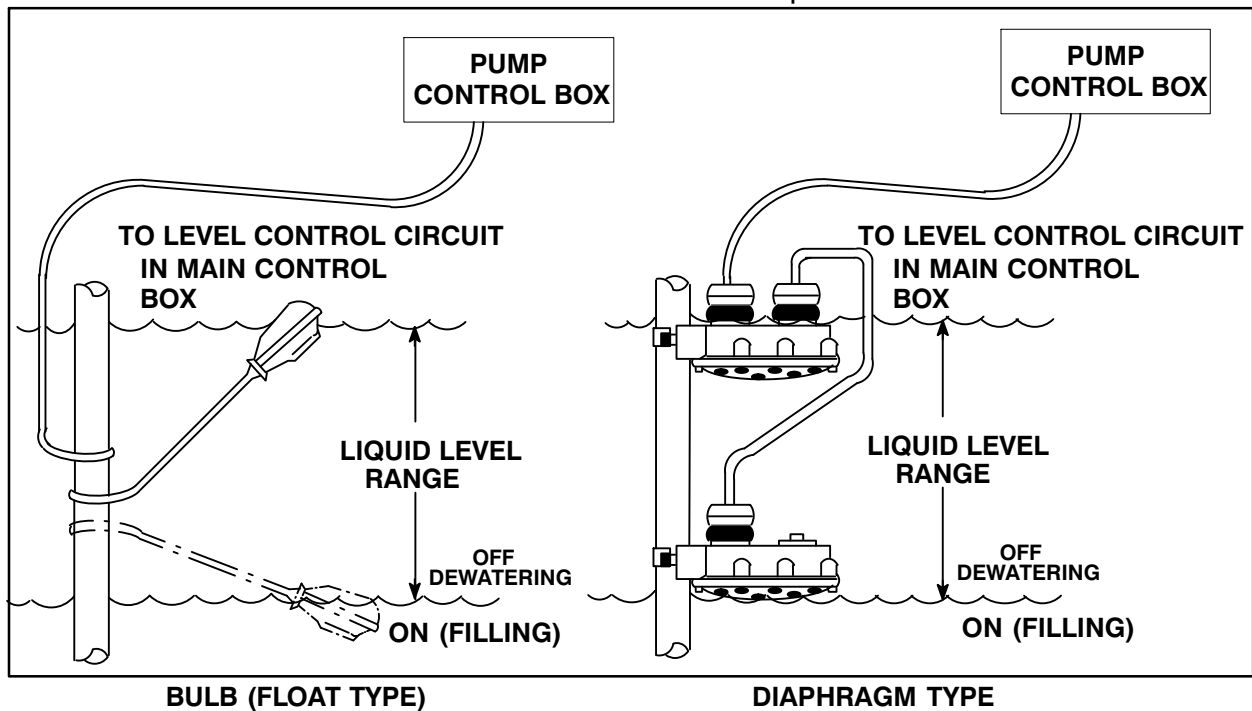

Figure B-3. Liquid Level Devices

OPERATION – SECTION C

GENERAL INFORMATION

Review all SAFETY information in Section A.



This pump is not designed to pump volatile, flammable, or corrosive liquids. The maximum temperature of the liquid being pumped should not exceed 104°F (40°C); do not apply the pump at higher temperatures. Do not attempt to pump any liquids which may damage the pump or endanger personnel as a result of pump failure.

Follow the instructions on all tags, labels and decals attached to the pump.

Pump Performance

Refer to the pump Specification Data Sheet for the specific performance for your pump.

Control Box



The motor powering this pump is approved by either CSA and/or FM for Class 1, Division 1, Groups C and D environments. Refer to the nameplate on your pump for agency approval information. Any liquid level devices used with the pump must be intrinsically safe for use in these environments

Any control box used to operate the pump must meet all applicable local and national codes for the application. If the control box is to be installed in an explosive environment, it must be a Nema 7 rating or better. If a non-explo-

sion proof control box is used, it must be located outside the explosive environment. Improper location of a non-explosion proof control box could result in destruction of equipment, injury, or death to personnel.

See the operating instructions furnished with the control box, and with other optional accessories and controls, before attempting to start the pump.

PUMP OPERATION

Liquid Temperature and Overheating.



Overheated pumps can cause severe burns and injury. If the pump becomes overheated:

1. Stop the pump immediately.
2. Lock out the power to the control panel to ensure that the pump will remain inoperative.
2. Allow the pump to completely cool if overheated.
3. Close the discharge valve (if used).
4. Refer to instructions in this manual before restarting the pump.

Overheating can occur if the pump is misapplied; if it is started more than 10 times within one hour; if the control box fails to provide overload or thermal protection, or if the pump is operated against a closed discharge valve for an extended period of time.

The submersible motor is cooled by the liquid being pumped. To minimize the chance of over-heating when installed in a **simplex** application, it is recommended that at least one-half of the motor remain immersed in the liquid.

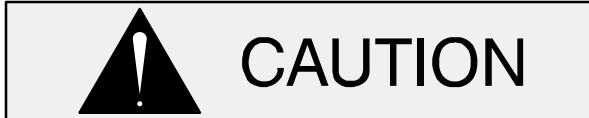

Do not start the pump more than 10 times per hour. If the motor does not cool between starts it will overheat, resulting in damage to the motor windings or control box components.

When installed in a standard alternating **duplex** application, where one pump runs while the other is shut down, the pump may be operated continuously until fully exposed. The shut down cycle will provide sufficient time for the motor to cool.

STARTING, STOPPING, AND OPERATIONAL CHECKS

Starting

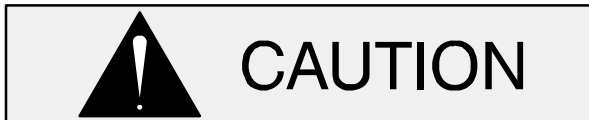

Do not attempt to operate the pump until impeller rotation has been checked; improper rotation will affect pump performance and may damage the pump.

Follow the instructions accompanying the control box, start the pump, and run any recommended checks.

Stopping

Follow the instructions accompanying the control box for stopping the pump.



The integral thermal overload device will shut off the motor if the temperature rises above design limits. When the pump cools and the temperature falls below these limits, the motor will restart automatically. To avoid the hazards of an unexpected motor start-up, do not at-

tempt to handle or service the pump unless all power to the motor has been shut off and locked out at the control box; otherwise, serious personal injury could result.

During motor shutoff by the thermal overload device, control box circuits remain live. Do not attempt to service any control box components unless incoming power has been shut off.

After stopping the pump, be sure to perform all required maintenance and preservation procedures.

Operational Checks

To detect minor problems, check the pump for proper operation when it is first started, and at periodic intervals during operation.



To avoid serious damage to the pump, check for unusual noises or excessive vibration while the pump is running. If noise or vibration is excessive, stop operation and refer to the troubleshooting chart in Section D.

The suction inlet or impeller may become clogged with debris. In some cases, stopping the pump momentarily may backflush this blockage. If backflushing does not clear the debris, remove the pump from the sump or wet well and clear manually.



Never introduce air or steam pressure into the pump casing to remove a blockage. This could result in personal injury or damage to the equipment. If backflushing is absolutely necessary, limit liquid pressure input to 50% of the maximum permissible operating pressure shown in the pump performance curve

(refer to the pump Specification Data Sheet).

Check the pump for overheating. Overheating can occur if the pump is misapplied, required to start repeatedly, if the control box fails to provide overload or thermal protection, or if the pump is operated against a closed discharge valve for an extended period of time.

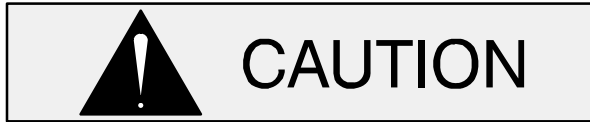

Do not start the pump more than 10 times per hour. If the motor does not cool between starts it will overheat, resulting in damage to the motor windings or control box components.



Do not attempt to thaw the pump by using a torch or other source of flame. This could damage O-rings or heat the oil in the seal housing above critical temperatures, causing the pump to rupture or explode.

COLD WEATHER PRESERVATION

The pump will not freeze as long as the casing is submerged in liquid. If the casing is not submerged, or if the liquid begins to freeze, remove the pump from the sump or wet well and dry it thoroughly. Run the pump for two or three minutes to dry the inner walls.

If the pump does freeze while it is out of the liquid, submerge it until thawed; if the liquid is near freezing, the pump must be submerged for an extended period of time. Check thawing by starting the pump and checking that the shaft rotates freely. If the pump remains frozen, allow additional thawing time before attempting to restart.

If submerging does not thaw the pump, move it into a warm area until completely thawed.

LUBRICATION

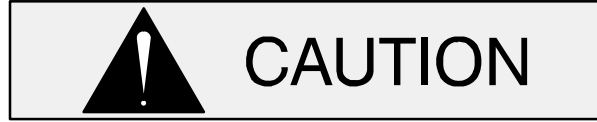

Before installing or removing the lubrication plugs, always make sure the pump is completely cool, and clean the area around the plugs to prevent contamination of the oil.

Check the oil level in the seal cavity before initial startup, after the first two weeks of operation, and every month thereafter.



Check the oil level only when the pump is cool. If the oil level plug is removed when the pump is hot, pressure in the seal cavity can cause hot oil to be ejected as the plug is removed.

Draining Oil

Lay the pump flat on a work surface with one of the lubrication plugs facing up. Remove the plug slowly to release any pressure in the seal housing.

Place a clean container under the other (lower) plug. Remove the plug and roll the pump on its side to drain the seal housing.

Condition Of Oil

Check the condition of the oil drained from the pump. Clear oil indicates that the lower pump seal is functioning properly. If the oil is milky or contains water, the lower seal must be changed before the pump is put back in operation.

Adding Oil

Remove the lubrication plugs as indicated in **Draining Oil**. Position the pump upright and add premium quality submersible pump oil through one of the plug holes until the oil reaches the bottom of the hole. Clean and re-install the plugs.

The grade of lubricant used is critical to the operation of this pump. Use premium quality hydraulic oil as specified in Table C-1.

Table C-1. Pump Oil Specifications

Specifications:	
Type	Premium high viscosity index, anti-wear hydraulic oil
Viscosity @ 100°F (38°C)	110 to 155
Viscosity @ 210°F (99°C)	40 to 50
Dielectric	26,000 (volts-min)
Recommended supplier:	
Gulf Oil Company	Gulf Harmony HVI AW 26
Acceptable alternate suppliers:	
Gulf Oil Company	Gulf Harmony 32 AW
Texas Oil Company	Rando HD 32 or HD AZ 32
Sun Oil Company	Sunvis 816 or 916
British Petroleum Oil Company	Energol-HLP 32
Shell Oil Company	Tellus 32, Tellus T-23 or T32
ARCO	Duro 32
Exxon	Nuto H 32

TROUBLESHOOTING – SECTION D

Review all SAFETY information in Section A.



The following precautions should be taken before attempting to service the pump; otherwise, injury or death could result.

1. Familiarize yourself with this manual and with all other literature shipped with the pump.
2. Lock out incoming power to the pump or control box to ensure that the pump will remain inoperative.

3. Allow the pump to completely cool if overheated.
4. Check the temperature before opening any covers, plates or plugs.
5. Close the discharge valve (if used).

NOTE

*Many of the probable remedies listed below require use of electrical test instruments; for specific procedures, see **ELECTRICAL TESTING** following the chart.*

TROUBLE	POSSIBLE CAUSE	PROBABLE REMEDY
PUMP FAILS TO START	No power to motor. Impeller jammed. Motor, voltage or control box incompatible; defective connections. Motor cable damaged. Control box current interrupting or moisture-sensing devices tripped. Open circuit in motor windings or cable. Motor overheated, thermal switches tripped.	Check for blown fuse or open circuit breaker. Check Impeller; disassemble and repair as necessary. Check ratings on pump nameplate and control box; check incoming voltage; check connections. Check (see Electrical Testing). Check control box; check for leaking shaft seals, cut O-rings, or moisture wicking through cable. Check continuity (see Electrical Testing). Allow motor to cool.

TROUBLE	POSSIBLE CAUSE	PROBABLE REMEDY
<p>MOTOR RUNS BUT FAILS TO DELIVER RATED FLOW OR PRESSURE</p>	<p>Pump running backwards.</p> <p>Voltage too low or too high; excessive voltage drop between pump and control.</p> <p>Discharge head too high.</p> <p>Discharge throttling valve partially closed; check valve improperly installed.</p> <p>Impeller or discharge line clogged.</p> <p>Liquid being pumped too thick.</p> <p>Impeller worn or damaged.</p> <p>Insufficient liquid in wet well.</p>	<p>Check and correct impeller rotation (see Rotation in Installation and Operation Manual).</p> <p>Check incoming voltage; check cable length.</p> <p>Reduce discharge head, or install staging adaptor and additional pump</p> <p>Open discharge valve; check piping installation.</p> <p>Check and clear as necessary.</p> <p>Dilute liquid if possible.</p> <p>Replace.</p> <p>Stop pump until liquid level rises; install liquid level devices.</p>
<p>PUMP STARTS THEN SHUTS OFF</p>	<p>Clogged suction port or impeller causing motor to overload.</p> <p>Motor overheated; thermal switch tripped.</p> <p>Moisture sensing device tripped.</p> <p>Motor bearings defective.</p>	<p>Clear blockage; reset overload device in control box.</p> <p>Allow pump to cool.</p> <p>Return pump to factory or authorized repair facility.</p> <p>Return pump to factory or authorized repair facility.</p>
<p>EXCESSIVE NOISE OR VIBRATION</p>	<p>Motor cable damaged.</p> <p>Insufficient liquid in wet well.</p> <p>Pump operating outside designed operating range.</p> <p>Impeller clogged.</p> <p>Impeller loose or damaged.</p> <p>Motor shaft or bearings defective.</p> <p>Pumping entrained air.</p>	<p>Check (see Electrical Testing).</p> <p>Stop pump until liquid level rises; install liquid level devices.</p> <p>Check discharge head and flow; adjust as required to meet performance specifications.</p> <p>Clear blockage.</p> <p>Check impeller; replace if necessary.</p> <p>Replace.</p> <p>Check wet well liquid level; install baffles if required.</p>

ELECTRICAL TESTING

Make the electrical checks which follow to determine if pump malfunctions are being caused by problems in the motor or in the power cable.

Test Equipment

A volt/amp/ohmmeter and megohmmeter of adequate range and quality are required to conduct the electrical tests which follow. Use commercially available equipment as listed below.

Equipment	Use
Ammeter	To check AC Voltage and current (amperage)
Ohmmeter	To measure resistance (ohms) to ground



Refer to the wiring diagram(s) accompanying the motor and control box before reconnecting any electrical leads which have been disconnected. Connections to the wrong terminals may damage the motor and/or control devices.

Voltage Imbalance

Use a voltmeter to read each phase of the incoming 3-phase power. Each phase must balance with the other two as closely as can be measured with a commercial instrument. If the phases are out of balance, contact your power company. If the phases are balanced, check out the motor as described in the following steps:

- a. Use a voltmeter, Amprobe, or equivalent instrument to read the voltage of incoming power lines 1 and 2, 2 and 3, and 1 and 3 at the control box. Voltage must match as closely as

can be measured. If possible, measure the voltage at the control box with:

1. The pump off.
2. The pump running in air.
3. The pump submerged and running under full load.

The voltage measured under each condition must be the same.

- b. If voltage is balanced when the pump is off but is imbalanced when the pump is running, thoroughly check the power source, all inter-connecting cables, and the pump motor to isolate the defect.
- c. Use an Amprobe or equivalent instrument to measure the current draw (amperage) of each phase while the pump is running under full load, and with no load. In each condition, the amperage readings for all three phases must match as closely as can be measured. Normal amperage values are listed in Table 1, Section B; these values apply only when the voltage at the site is the normal voltage listed.

Motor and Power Cable Continuity

Set the megohmmeter at R x 1 scale and zero-balance it. Test as follows:

- a. Shut off incoming power to the control box, and disconnect the motor power cable leads. Connect the megohmmeter test leads to any two power cable leads, and note the megohm meter reading. A high resistance reading indicates an open or broken circuit in the power cable or motor windings, or a bad connection between the motor and cable.
- b. Repeat Step a. with each set of leads. The three readings should be as close as can be measured.
- c. If readings indicate that continuity problems exist in the motor or power cable, the motor must be returned to the factory or to a Gorman-Rupp authorized repair facility.

Insulation Resistance

Set the megohmmeter at R x 100, and zero-balance it. Test as follows:

- a. Shut off incoming power to the control box, and disconnect the motor power cable leads. Connect one megohmmeter test lead to the motor cable green/yellow ground lead. Touch the other test lead to each of the motor cable leads in turn. Note the readings.
- b. Readings will indicate resistance values in both the power cable and motor windings. If resistance reads infinity (∞), insulation is good. If resistance reads between infinity (∞), and 1 megohm, insulation is acceptable but should be rechecked regularly. If resistance reads less than 1 megohm, insulation should be checked more closely and frequently.
- c. If readings indicate that a ground exists, the motor must be returned to the factory or to a Gorman-Rupp authorized repair facility.

PUMP MAINTENANCE AND REPAIR – SECTION E

GENERAL INFORMATION

Review all SAFETY information in Section A.



Do not attempt to service the pump assembly unless all power to the motor has been shut off at the control box; otherwise, injury or death could result.

Select a suitable location, preferably indoors, to perform required maintenance. All work must be performed by qualified personnel.

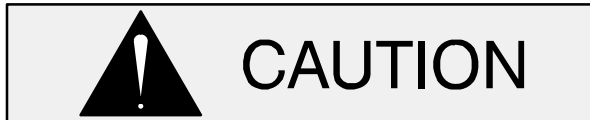

The motor powering this pump is approved by either CSA and/or FM for Class 1, Division 1, Groups C and D environments. Refer to the nameplate on your pump for agency approval information. All repairs to the pump, other than seal, impeller and other hydraulic components, must be performed by a Gorman-Rupp authorized repair facility or the factory. Any repairs to the motor assembly performed by the customer or an unauthorized repair facility negates the agency approval and the motor warranty.

Check **TROUBLESHOOTING**, Section D to determine causes and remedies of pump problems.

This section of the manual provides maintenance instructions required to properly service the pump

hydraulic components only. Pump motor maintenance may be performed **only** by a Gorman-Rupp authorized repair facility, or the factory. Otherwise, the pump warranty will be negated, and damage to the pump, and injury or death to personnel can result. Contact the factory for the authorized repair facility closest to you.

Lifting



Death or serious personal injury and damage to the pump or components can occur if proper lifting procedures are not observed. Make certain that hoists, chains, slings or cables are in good working condition and of sufficient capacity and that they are positioned so that loads will be balanced and the pump or components will not be damaged when lifting. Do not attempt to lift this pump by the motor or control cables, or the piping. Attach proper lifting equipment to the lifting bail fitted on the pump. Lift the pump or component only as high as necessary and keep personnel away from suspended objects.

Pump unit weights will vary depending on the pump application. Check the shipping tag on the unit packaging for the actual weight, and use lifting equipment with appropriate capacity. Drain the pump and remove all customer-installed equipment such as discharge hoses or piping before attempting to lift existing, installed units.

ILLUSTRATION

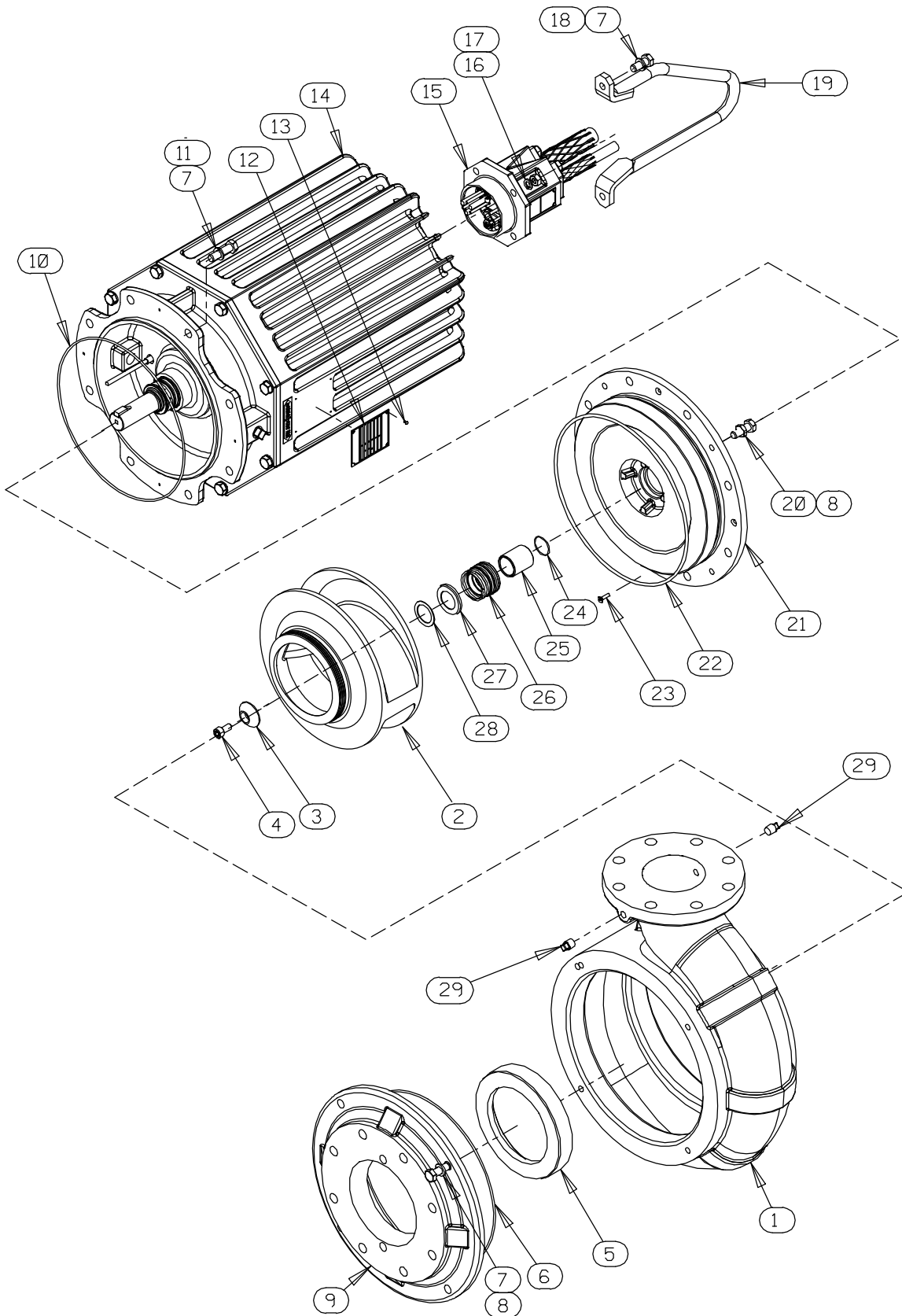

Figure E-1. SF4A-X Pump Model Assembly

**SF4A-X Pump Model Assembly
Parts List
(From S/N 1746760 Up)**

ITEM NO.	PART NAME	PART NUMBER	QTY	ITEM NO.	PART NAME	PART NUMBER	QTY
1	PUMP CASING				OPTIONAL:		
	☞ -ANSI	SEE NOTE BELOW	1		ANSI SLIDE RAIL VERSION		
	☞ -DIN	SEE NOTE BELOW	1		NON-SPARKING GUIDE		
2 *	IMPELLER	SEE NOTE BELOW	1		SHOE KIT	48156-568	1
3 *	IMPELLER WASHER	31514-017 17000	1		-GUIDE SHOE SEAL	31513-054 19020	1
4 *	SOCKET HD CAP SCREW	MBD1020 17000	1		SLIDE RAIL KIT	48156-024	1
5 *	WEAR RING	38691-368 11010	1		BASEPLATE KIT		
6 *	O-RING	25152-277	1		-SHORT	48156-603	1
7	LOCK WASHER	MJ12 17000	14		-LONG	48156-604	1
8	HEX HD CAP SCREW	MB1235 17000	8		LIFTING CABLE KIT		
9	SUCTION HEAD				-36'	48151-502	1
	-ANSI	38246-619 10000	1		-50'	48156-504	1
	-DIN	38246-620 10000	1		DIN SLIDE RAIL VERSION		
10 *	O-RING	25152-276	1		NON-SPARKING GUIDE		
11	HEX HD CAP SCREW	MB1245 17000	8		SHOE KIT	48156-569	1
12	NAME PLATE	NOT AVAILABLE			-GUIDE SHOE SEAL	31513-054 19020	1
13	DRIVE SCREW	NOT AVAILABLE			SLIDE RAIL KIT	CONSULT FACTORY	1
14	MOTOR ASSEMBLY	CONSULT FACTORY			BASEPLATE KIT		
15	TERM HOUSING ASSY	NOT AVAILABLE			-SHORT	CONSULT FACTORY	1
16	LOCK WASHER	NOT AVAILABLE			-LONG	CONSULT FACTORY	1
17	HEX NUT	NOT AVAILABLE			LIFTING CABLE KIT		
18	HEX HD CAP SCREW	MB1230 17000	2		-36'	48151-502	1
19	LIFTING BAIL ASSEMBLY	44713-048 17040	1		-50'	48151-504	1
20	JAM NUT	MAT12 17000	4		ANSI TRASH VERSION		
21	SEAL PLATE	38272-536 11010	1		STAND KIT	48786-210	1
22 *	O-RING	25152-379	1		DISCH ELBOW KIT	48135-102	1
23	FLAT HEAD CAP SCREW	MF0520 17000	4		INCREASER KIT	48135-502	1
24 *	O-RING	25154-022	1		DIN TRASH VERSION		
25 *	SHAFT SLEEVE	31441-030 1706H	1		STAND KIT	48786-214	1
26 *	MECH SEAL 1-1/2	25285-856	1		DISCH ELBOW KIT	48135-106	1
27 *	SPRING RETAINER	31161-042 17000	1		LIQUID LEVEL DEVICES:		
28 *	ADJ. SHIM SET	37J 17090	1		DIAPHRAGM TYPE	GRP48-03	1
☞29	PIPE PLUG	P04 17000	2		FLOAT TYPE	GRP48-06	1
NOT SHOWN:					120V LIQUID LEVEL	27471-180	1
	G-R DECAL	GR-03	1		CONTROL RELAY	27521-321	1
☞		INCLUDED W/ANSI REPAIR PUMP CASING ASSY			46472-912		1
☞		INCLUDED W/DIN REPAIR PUMP CASING ASSY			46472-919		1

* INDICATES PARTS RECOMMENDED FOR STOCK

NOTE: WHEN ORDERING A REPLACEMENT IMPELLER, PROVIDE THE FACTORY WITH THE PUMP MODEL, S/N AND IMPELLER DIAMETER (FROM NAMEPLATE)

PUMP END DISASSEMBLY AND REASSEMBLY

Review all **SAFETY** information in Section A.

This manual will alert personnel to known procedures which require special attention, to those which could damage equipment, and to those which could be dangerous to personnel. However, this manual cannot possibly anticipate and provide detailed precautions for every situation that might occur during maintenance of the unit. Therefore, it is the responsibility of the owner/maintenance personnel to ensure that **only** safe, established maintenance procedures are used, and that any procedures not addressed in this manual are performed **only** after establishing that neither personal safety nor pump integrity are compromised by such practices.



Do not attempt to service the pump assembly unless all power to the motor has been shut off at the control box; otherwise, injury or death could result.



Death or serious personal injury and damage to the pump or components can occur if proper lifting procedures are not observed. Make certain that hoists, chains, slings or cables are in good working condition and of sufficient capacity and that they are positioned so that loads will be balanced and the pump or components will not be damaged when lifting. Do not attempt to lift this pump by the motor or control cables, or the piping. Attach proper lifting equipment to the lifting bail fitted on the pump. Lift the pump or component only as high as necessary and keep personnel away from suspended objects.



If the pump is used to handle liquids which may cause illness or disease through direct exposure, take necessary precautions during maintenance and repair to prevent personal contamination.

Select a suitable location, preferably indoors, to perform required maintenance. All work must be performed by qualified personnel.

Check the chart in **TROUBLESHOOTING**, Section D of this manual, to determine the nature of the pump problem. If the problem is mechanical in nature, such as worn pump parts, seal replacement, lubrication, etc., refer to the following instructions.

If the problem is electrical, maintenance may be performed **only** by a Gorman-Rupp authorized repair facility, or the factory. Otherwise, the pump warranty will be negated, and damage to the pump, and injury or death to personnel can result. Contact the factory for the authorized repair facility closest to you.



The electrical power used to operate this pump is high enough to cause injury or death. Make certain that the control handle on the control box is in the off position and locked out, or that the power supply to the control box has been otherwise cut off and locked out, before attempting to open or service the pump assembly. Tag electrical circuits to prevent accidental start-up.

Carefully inspect any O-rings before removal and cleaning to determine if a proper seal and compression existed prior to disassembly. If sealing was faulty or questionable, the cause must be determined and corrected before reassembly. All O-rings **must** be replaced if disturbed.

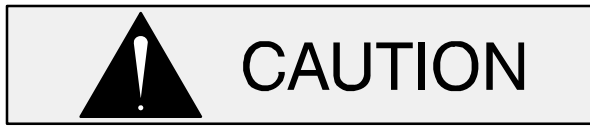

Use **Only Genuine Gorman–Rupp** replacement parts. Failure to do so may create a hazard and damage the pump or diminish optimal pump performance. Any such hazard, damage or diminished performance is not covered by the warranty.

NOTE

When appropriate recycling facilities are available, the user should recycle components and fluids when doing any routine maintenance / repairs and also at the end of the pump's useful life. All other components and fluids shall be disposed of according to all applicable codes and regulations.

PUMP END DISASSEMBLY

Preparing Pump for Disassembly

Use the hoisting bail to remove the pump from the wet well or sump, and move it to a suitable location for disassembly.

If the pump is designed for a guide rail application, it is not necessary to remove the guide shoe for most pump maintenance procedures. If removal of the guide shoe is desired, disengage the hardware securing the guide shoe to the pump casing and remove the guide shoe and guide shoe seal.

If the pump is designed for a stand application, disengage the hardware securing the pump to the stand before proceeding with pump maintenance.

Suction Head and Wear Ring Removal

Position the pump horizontally on a flat work surface and remove the hardware securing the suction head to the pump casing.

Use a pair of suitable tools to pry the suction head and assembled wear ring out of the pump casing.

Inspect the wear ring for excessive wear or scoring. If replacement is required, install two M12 x 1.75 x 76 mm long capscrews (not supplied) in the tapped holes in the suction head. Turn the screws

evenly in an alternating sequence to press the wear ring out of the suction head.

Pump Casing Removal

Position the pump assembly on a flat surface and use the lifting bail and lifting device to support the pump in a vertical position. Remove the hardware securing the motor assembly to the pump casing.

Using the lifting device, raise the motor assembly out of the pump casing. It may be necessary to tap around the circumference of the pump casing with a soft-faced mallet to break the seal between the casing and motor. When the motor is free of the pump casing, position the motor and remaining pump end components horizontally on a flat surface for further disassembly. Chock the pump to prevent rolling when positioned horizontally.

Remove the O-ring from the outer shoulder of the seal plate.

Draining Oil From Seal Cavity

The seal cavity oil must be drained to prevent the oil from escaping as the impeller is removed.



Let the pump cool before removing the seal cavity drain plug. Pressure built up within a hot pump could cause the oil to spray out when the plug is removed. Remove the plug slowly and permit pressure to vent to atmosphere.

Lay the pump on its side with one of the pipe plugs facing up. Clean any dirt from around the plug. Remove the plug slowly to release any pressure and install a short pipe nipple in the hole. Roll the pump and drain the seal oil into a **clean** container. Inspect the oil for water, dirt, or cloudy condition which could indicate lower seal failure or poor O-ring seal.

Impeller Removal

Wedge a soft metal rod between the impeller vanes to prevent impeller rotation.

NOTE

A strap wrench may also be used to immobilize the

impeller.

Remove the impeller capscrew. A hex key used in conjunction with an impact wrench can also be used to remove the impeller screw.

Remove the impeller washer. Remove the metal rod or strap wrench used to immobilize the impeller.

To remove the impeller, use two thin-bladed screwdrivers positioned 180° apart to pry on the back of the impeller and “walk” the impeller off the shaft. Use increasingly larger screwdrivers (or wedges) as necessary. After the impeller comes free of the shaft, retain the impeller key.

Remove the impeller adjusting shims. Tie and tag the shims for ease of reassembly.

If no further disassembly is required, proceed to the appropriate areas in **PUMP END REASSEMBLY**.

Seal Removal

Carefully remove the spring retainer (if so equipped) and seal spring. Slide the shaft sleeve and rotating portion of the seal off the shaft as a unit.

Apply oil to the sleeve and work it up under the rubber bellows. Slide the rotating portion of the seal off the shaft sleeve.

Work a pair of stiff wires with hooked ends between the rotor shaft and the stationary seat and pull the stationary seat and O-ring out of the seal plate.

NOTE

An alternate method of removing the stationary element is to remove the screws securing the seal plate to the motor assembly. Pry the assembled seal plate and stationary element off the shoulder of the intermediate. Remove the O-ring and press the stationary element and seat out of the seal plate from the back side.

Remove the seal sleeve O-ring from the rotor shaft.

Proceed to **PUMP END REASSEMBLY**.

PUMP END REASSEMBLY

NOTE

Reuse of old O-rings or shaft seal parts will result in premature leakage or reduced pump performance. It is strongly recommended that new O-rings and a new shaft seal be used during reassembly (see the parts lists for part numbers).

Hardware Torque Values

When reassembling the pump, use the following table to determine the proper torque values for hardware.

Table E-1. Hardware Torque Values

FASTENER SIZE	TIGHTENING TORQUE			
	DRY		LUBRICATED	
	FT. LBS.	NM	FT. LBS.	NM
M3	0.8	1,1	0.7	1,0
M4	1.9	2,6	1.2	1,7
M5	3.8	5,1	2.5	3,4
M6	6.5	8,8	52.2	4,3
M8	15.8	21,4	10.7	14,5
M10	32.4	44	22.1	30
M12	54.8	74	36.9	50
M14	87.8	119	58.3	79
M16	135.0	183	89.2	121
M20	273.0	370	180.0	244
M24	220.0	298	145.3	197
M30	421.0	571	276.0	374

Cleaning and Inspection of Pump Parts

With the pump inverted, stuff a clean tissue into the stationary seal seat bore of the intermediate or wrap a small rag around the shaft to prevent foreign material from entering the motor cavity.

Carefully inspect any O-rings before removal and cleaning to determine if a proper seal existed prior to disassembly. If sealing was faulty or questionable, the cause must be determined and corrected before reassembly. Replace any parts as required.

Thoroughly clean all reuseable parts with a soft cloth soaked in cleaning solvent. Remove all O-rings and clean the sealing surfaces.



Most cleaning solvents are toxic and flammable. Use them only in a well ventilated area free from excessive heat, sparks, and flame. Read and follow all precautions printed on solvent containers.

Inspect the rotor shaft for damaged threads, scoring, or nicks. Remove nicks and burrs with a fine file or hand honing stone to restore original contours. If the shaft is bent or severely damaged, the motor must be replaced.

The shaft seal assembly should not be reused because wear patterns on the finished faces cannot

be realigned during reassembly. This could result in premature failure.

Handle the seal parts with extreme care to prevent damage. Be careful not to contaminate the precision finished faces; even fingerprints on the faces can shorten seal life. If necessary, clean the faces with a non-oil based solvent and a clean, lint-free tissue. Wipe **lightly** in a circular pattern to avoid scratching the faces.

Inspect the seal components for wear, scoring, grooves, and other damage that might cause leakage. If any components are worn, replace the complete seal; **never mix old and new seal parts.**

Install the shaft seal as shown in the following illustration.

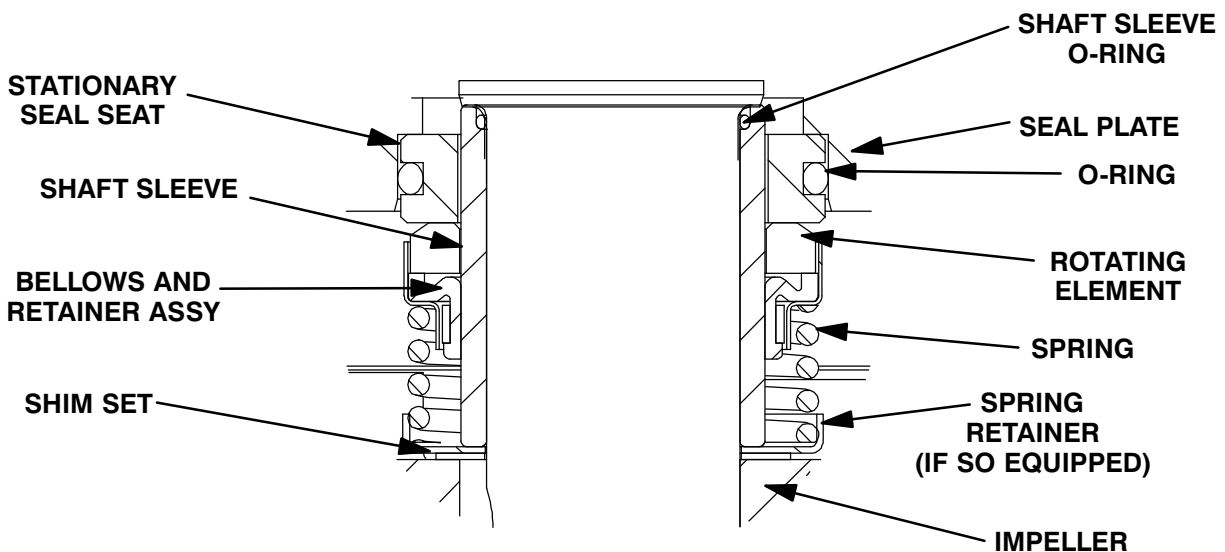

Figure E-11. Lower Seal Assembly



The seal assembly is not designed for operation at temperatures above 104°F (40°C). Do not use at higher operating temperatures.

Seal Installation

Thoroughly clean the O-ring surfaces and seal bore of the seal plate. The seal bore must be free of

burrs and nicks which could damage the seal. Inspect the seal plate for cracks, distortion, or erosion and replace it if defective.

Lubricate the seal sleeve O-ring with light oil and slide it onto the rotor shaft until it is seated against the shaft shoulder. Use caution not to nick or damage the O-ring on the shaft keyway.

Position the seal plate on a clean flat surface with the impeller side up.

Unpack the seal stationary seat and O-ring. Apply a **light** coating of oil to the seal plate bore and the

O.D. of the stationary seat O-ring. Keep the sealing face dry.

Position the stationary seat and O-ring in the seal plate bore with the sealing face up and cover the seal face with a clean tissue. Use your thumbs to press the assembly into the bore. Apply equal pressure on opposite sides until the seat contacts the bore shoulder. Remove the tissue and inspect the seal face to ensure that it is clean and dry. If cleaning is necessary, use clean tissue to wipe **lightly** in a circular pattern.

NOTE

If the seal plate was not removed during disassembly, cover the stationary element with a clean tissue and use your thumbs to press the seal stationary seat and O-ring into the seal plate as described above. Remove the tissue and inspect the seal face to ensure that it is clean and dry.

Install a new O-ring on the shoulder of the intermediate.

Carefully position the seal plate and stationary seal components on the rotor shaft. Align the holes in the seal plate for the capscrews with those in the intermediate and slide the seal plate onto the shaft until fully seated against the intermediate. **Be careful** not to damage the stationary seat already installed in the seal plate. Secure the seal plate to the intermediate with the flat head capscrews.

Unpack the rotating portion of the seal. Be certain the seal face of the rotating element is free of grit or surface damage. Because the rotating element may not stay in the bellows retainer when turned upside down, place a **small** amount of grease at equal spaces on the back of the element and position it in the bellows retainer. The grease should hold the element in position until the seal is installed. Assemble the drive grooves of the rotating element into the drive lugs of the bellows retainer.

Lubricate the I.D. of the bellows with water and slide the rotating subassembly over the shaft sleeve until the seal face is just flush with the undercut end of the sleeve.

Slide the assembled shaft sleeve and rotating portion of the seal and onto the rotor shaft until the polished faces contact. Continue to push the sleeve

through the seal until it is fully seated against the shaft shoulder.

Install the seal spring over the bellows retainer and install the spring retainer (if so equipped). See Figure E-11 for proper order of seal assembly.

Impeller Installation

Inspect the impeller for cracks, broken vanes, or wear from erosion and replace it if damaged. Clean the threads on the rotor shaft for the impeller nut.

Install the same thickness of adjusting shims as previously removed. Install the impeller key in the rotor shaft keyway. Align the keyway in the impeller with the shaft key and push the impeller onto the shaft until seated firmly against the impeller shim set. If your pump is not equipped with a spring retainer, make sure the seal spring seats squarely over the shoulder on the back of the impeller.

A clearance of .020 to .040 inch (0,51 to 1,02 mm) between the impeller and the seal plate is recommended for maximum pump efficiency. Measure this clearance and add or remove impeller adjusting shims as required.

After the impeller is installed, coat the threads of the rotor/shaft or impeller capscrew with 'Loctite Threadlocker No. 242' or equivalent compound. Install the impeller washer. Wedge a soft metal bar between the vanes of the impeller or use a strap wrench to prevent shaft rotation. Torque the impeller nut or capscrew to the value shown in Table E-1.

Remove the metal bar or strap wrench used to prevent shaft rotation and turn the impeller to check for free rotation.

Suction Head and Wear Ring Installation

The suction head and wear ring must be installed in the pump casing before installing the pump casing in order to set the impeller-to-wear ring clearance.

If the wear ring was removed from the suction head, position the replacement wear ring in the suction head bore and use an arbor (or hydraulic) press to press the wear ring into the suction head until fully seated.

Install a new O-ring on the shoulder of the suction head. Position the suction head against the pump casing and use the previously removed hardware to press the suction head into the pump casing.

Adjust the impeller-to-wear ring clearance after installing the pump casing as described below.

Pump Casing Installation

Install a new O-ring on the shoulder of the seal plate. Slide the pump casing over the seal plate shoulder until fully seated. Apply “Never-Seez” or equivalent compound to the capscrews and secure the pump casing to the seal plate and motor assembly with the previously removed hardware. Torque the capscrews to the value shown in Table E-1.

Impeller Face Clearance Adjustment

A clearance of .006 to .012 inch (15 to 30 mm) between the face of the impeller and the wear ring is recommended for maximum pump efficiency.

Loosen the capscrews securing the pump casing to the motor assembly. Measure the clearance between the impeller and wear ring. If the clearance is too narrow, turn the adjusting screws in an alternating pattern to push the pump casing and suction head away from the impeller until the proper clearance is achieved. If the clearance is too wide, use the previously removed hardware to draw the pump casing and suction head toward the impeller until the proper clearance is achieved.

When the face clearance is properly set, secure the adjusting screws by tightening the jam nuts against the back of the seal plate.

Final Assembly

If the pump is designed for guide a rail application and guide shoe was removed for disassembly, install a new guide shoe seal and secure the seal and guide shoe to the pump casing with the previously removed hardware.

If the pump is designed for a stand application, secure the pump to the stand with the previously remove hardware.

Use a suitable lifting device to reposition the pump in the wet well or sump.

LUBRICATION

Seal Cavity

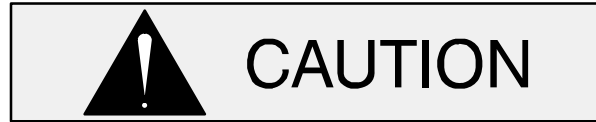

Before installing or removing the lubrication plugs, always make sure the pump is completely cool, and clean the area around the plugs to prevent contamination of the oil.

Check the oil level in the seal cavity before initial startup, after the first two weeks of operation, and every month thereafter.



Check the oil level only when the pump is cool. If the oil level plug is removed when the pump is hot, pressure in the seal cavity can cause hot oil to be ejected as the plug is removed.

Remove the lubrication plugs as indicated in **Draining Oil**. Position the pump upright and add premium quality submersible pump oil through one of the plug holes until the oil reaches the bottom of the plug hole. Clean and re-install the plugs. See Table E-2 for the quantity of oil required for your specific pump model.

The grade of lubricant used is critical to the operation of this pump. Use premium quality hydraulic oil as specified in Table E-3.

Table E-2. Pump Oil Quantities

Pump Model	Oil Quantity Oz. (Liters)
SF4A,	130 (3,8)

Table E-3. Pump Oil Specifications

Specifications:	
Type	Premium high viscosity index, anti-wear hydraulic oil
Viscosity @ 100°F (38°C)	110 to 155
Viscosity @ 210°F (99°C)	40 to 50
Dielectric	26,000 (volts-min)
Recommended supplier:	
Gulf Oil Company	Gulf Harmony HVI AW 26
Acceptable alternate suppliers:	
Gulf Oil Company	Gulf Harmony 32 AW
Texas Oil Company	Rando HD 32 or HD AZ 32
Sun Oil Company	Sunvis 816 or 916
British Petroleum Oil Company	Energol-HLP 32
Shell Oil Company	Tellus 32, Tellus T-23 or T32
ARCO	Duro 32
Exxon	Nuto H 32

**For Warranty Information, Please Visit
www.grpumps.com/warranty
or call:
U.S.: 419-755-1280
Canada: 519-631-2870
International: +1-419-755-1352**

GORMAN-RUPP PUMPS