



Basic Pedestal Standard Centrifugal Pump

Model VGH2C31-B

Size 3" x 2"

PUMP SPECIFICATIONS

Size: 3" x 2" (76 mm x 51 mm) Raised Face Flanges.

Casing: Ductile Iron.

Maximum Operating Pressure 172 psi (1186 kPa).*

Enclosed Type, Six Vane Impeller: Gray Iron 40.

Handles 25/64" (10 mm) Diameter Spherical Solids.

Impeller Shaft: Steel 1045.

Two Replaceable Wear Rings: Gray Iron 25.

Seal Plate: Ductile Iron.

Bypass Flush Piping.

Bearing Housing: Gray Iron 25.

Radial Bearing: Open Single Row Ball.

Thrust Bearing: Open Double Row Ball.

Bearing Lubrication: SAE 30 Non-Detergent Oil.

Gaskets: Nitrile Rubber.

Hardware: Standard Plated Steel.

Bearing Housing Level Oiler.

Optional Equipment: Strainer. NPT Suction and Discharge Flanges. Stainless Steel Impeller. Consult Factory for Optional Seals.



**Consult Factory for Applications Exceeding Maximum Pressure and/or Temperature Indicated.*

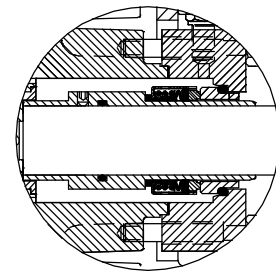
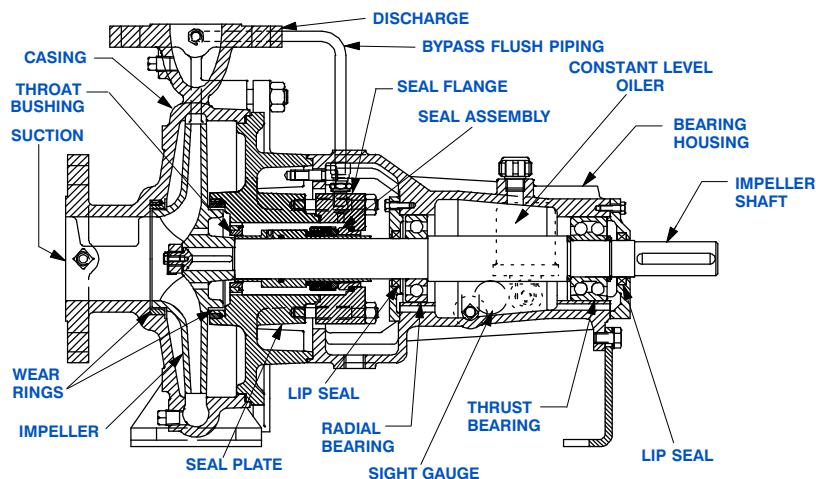

SEAL DETAIL

Mechanical, Self-Lubricated. Silicon Carbide Rotating and Stationary Faces. Fluorocarbon Elastomers (DuPont Viton® or Equivalent). Stainless Steel 316 Shaft Sleeve and Spring. Maximum Temperature of Liquid Pumped, 160°F (71°C).*



GORMAN-RUPP PUMPS

www.grpumps.com

Specifications Subject to Change Without Notice

Printed in U.S.A.

PERFORMANCE
BASED ON
WATER

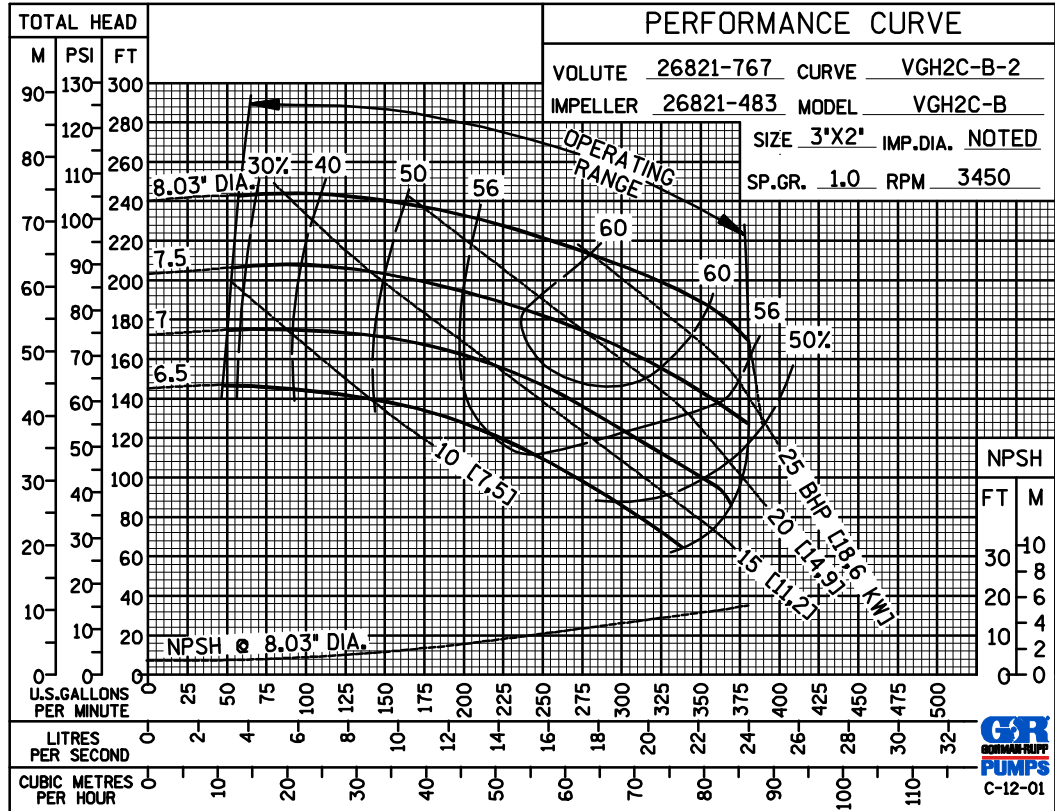

PERFORMANCE
BASED ON
WATER

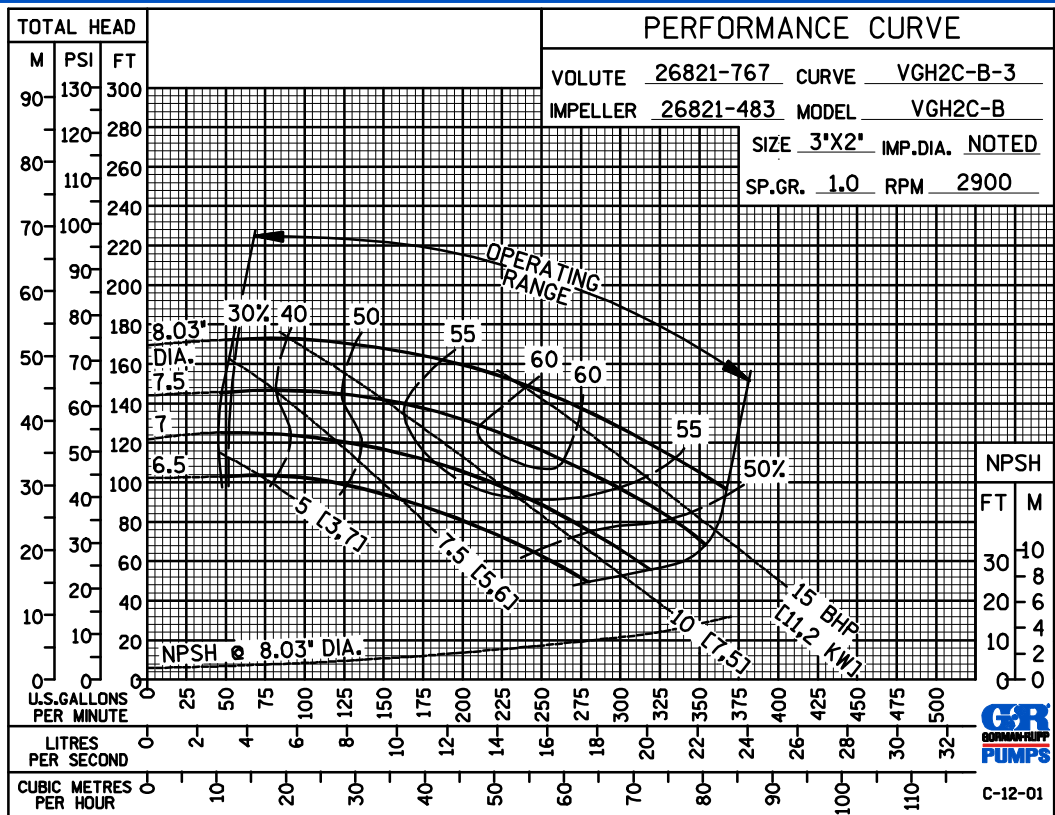

GORMAN-RUPP PUMPS

www.grpumps.com

Specifications Subject to Change Without Notice

Printed in U.S.A.

PERFORMANCE
BASED ON
WATER

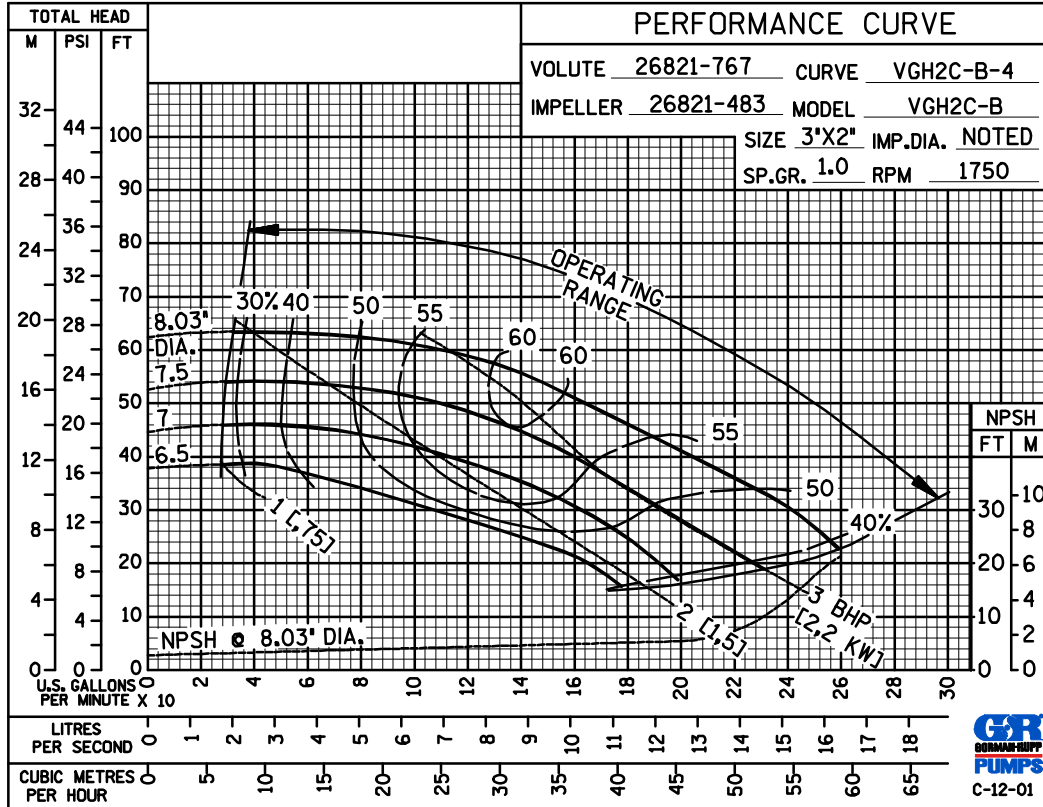

PERFORMANCE
BASED ON
WATER

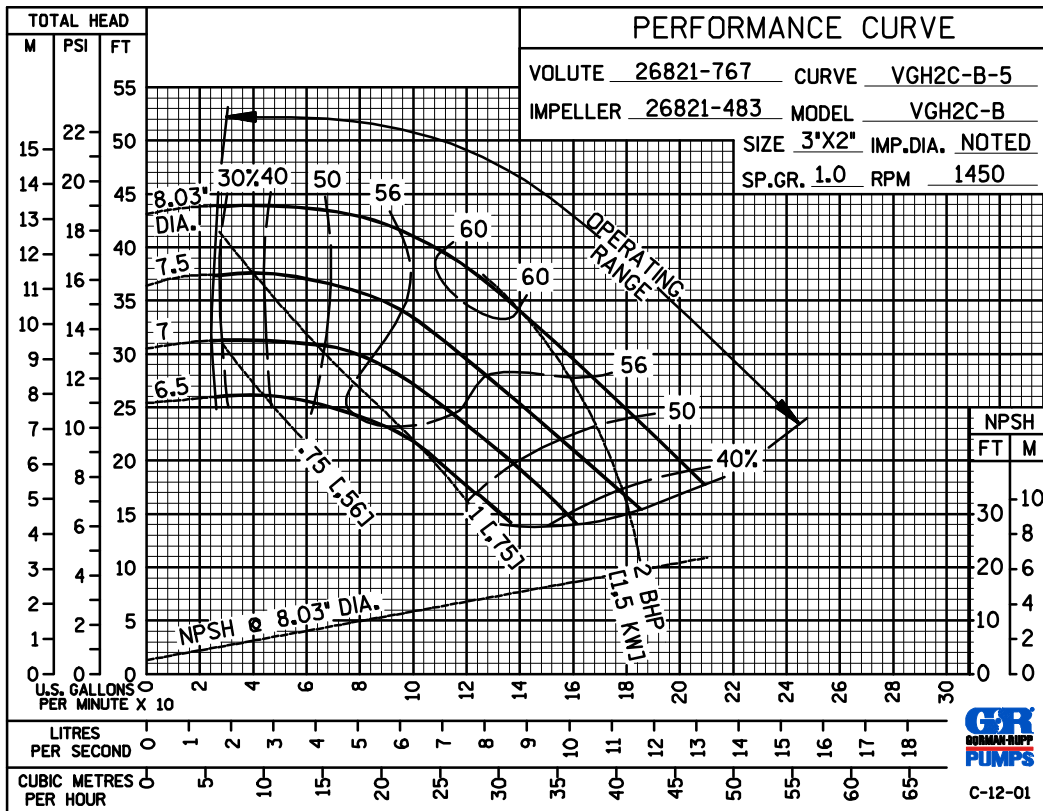

GORMAN-RUPP PUMPS

www.grpumps.com

Specifications Subject to Change Without Notice

Printed in U.S.A.

PERFORMANCE
BASED ON
PETROLEUM

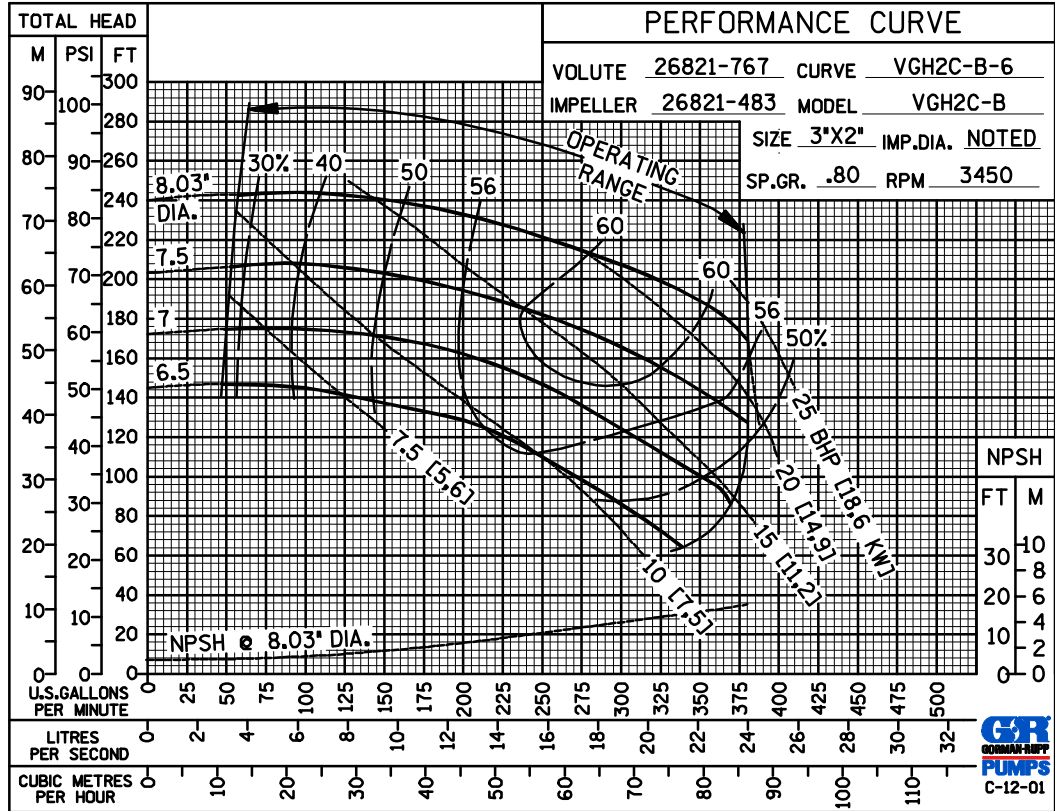

PERFORMANCE
BASED ON
PETROLEUM

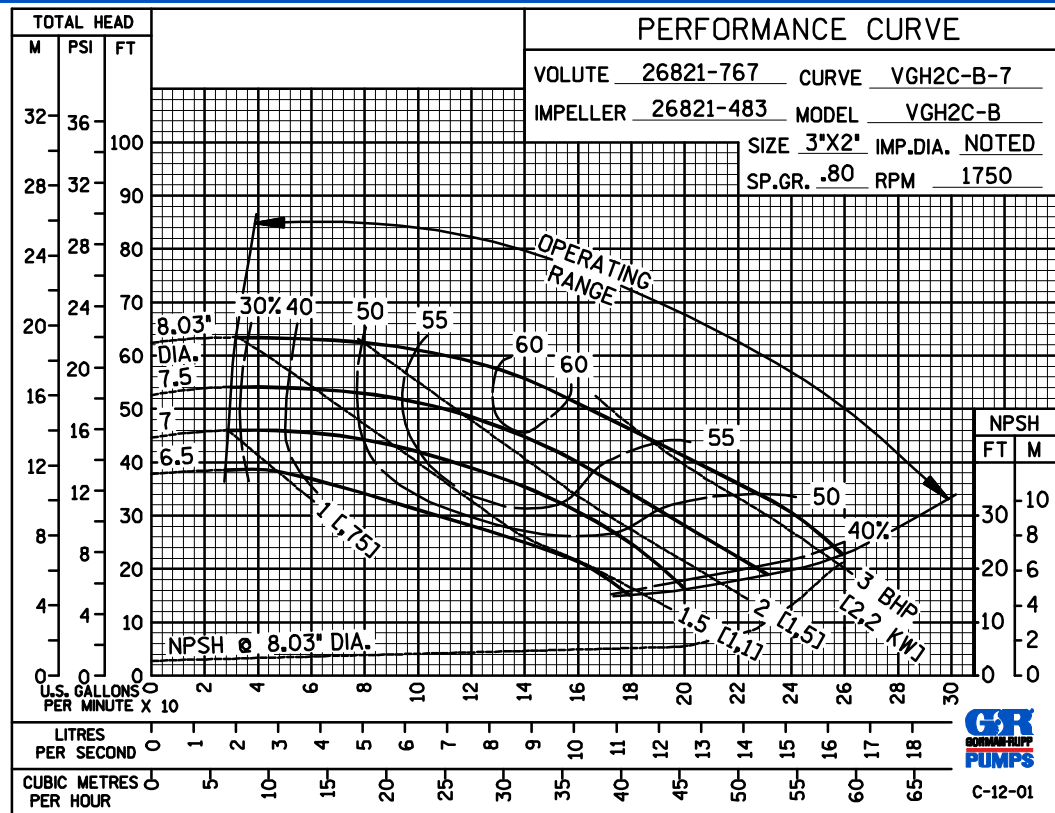

GORMAN-RUPP PUMPS

www.grpumps.com

Specifications Subject to Change Without Notice

Printed in U.S.A.