

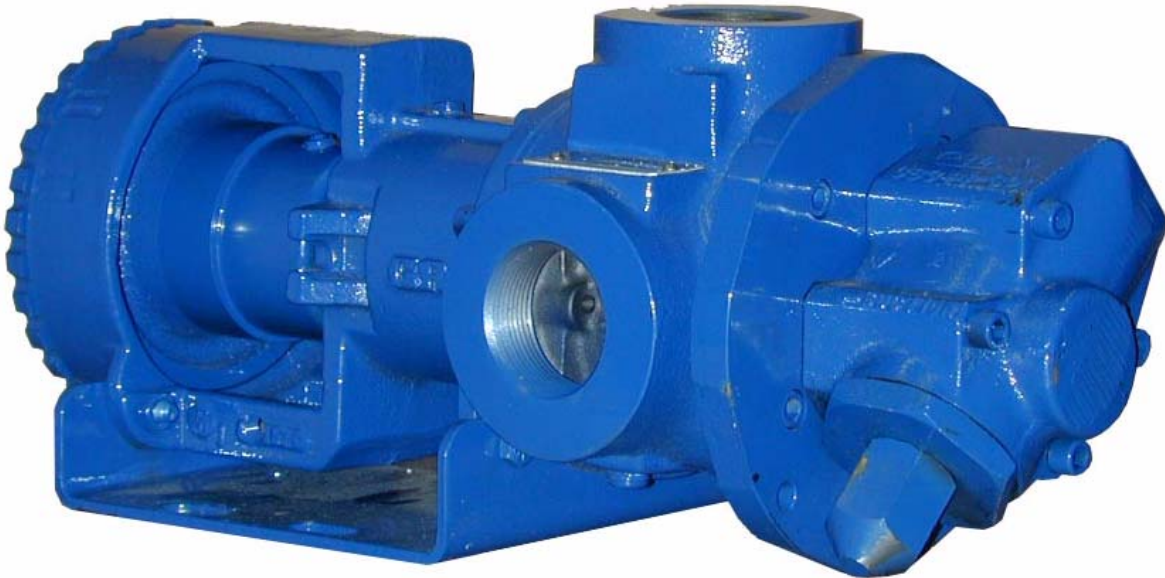

**HEAVY DUTY STANDARD;
 D, G, J, N & R HYD SIZE
 ROTARY GEAR PUMP**



The GHS iron series is designed for applications in the operating ranges noted below. These units are available with head and backhead jackets for temperature control, carbon graphite bushings for low viscosity liquids, silicon carbide bushings for wear resistance, and numerous shaft seal options described on the following pages

This heavy duty series provides superior rotor shaft support and an integral, maintenance-free radial/thrust bearing for reduced deflection and wear.

FEATURES

- 400 PSI CAPABILITY
- BALL BEARING THRUST CONTROL
- ROTOR END CLEARANCE EXTERNALLY ADJUSTABLE
- OPTIMIZED LOAD SUPPORT AND HIGH STRENGTH SHAFT
- HIGH STRENGTH, COMPUTER PROFILED GEARING FOR QUIET OPERATION
- FLEXIBLE SEAL DESIGN ALLOWS FOR A VARIETY OF INDUSTRY STANDARD SEALS OR PACKING
- INTERNAL SEAL VENT
- DEEP END FEED DESIGN

OPERATING RANGE

- CAPACITY (GPM) : (3 TO 295)
 [LPM] : [11 TO 1116]
- PRESSURE (PSI) : [0 TO 300]
 [BAR] : [0 TO 20.7]
- VISCOSITY (SSU) : (28 TO 2,000,000)
 [cSt] : [1 TO 440,000]
- TEMPERATURE (F) : (-60° TO 675°)
 [C] : [-51° TO 358°]

APPLICATIONS

- USE WITH ANY CLEAN LIQUID
 COMPATIBLE WITH CAST IRON
- ★ BOOSTER SERVICE
 - ★ CIRCULATING
 - ★ FILTERING
 - ★ LUBRICATING
 - ★ TRANSFERRING
 - ★ LOW PRESSURE FLUID POWER
 - ★ METERING

| EXTER- IOR | ROTOR & IDLER | HOUSING PORTS | BUSHINGS | IDLER PIN | SHAFT | SHAFT SEALING | | ROTATION | INTERNAL RELIEF VALVE | |
|---------------|--------------------------|---------------------------|----------|-------------------|-------|-----------------|-----------------|----------|--------------------------|-------------------|
| | | | | | | MECH. SEAL ● | PACKING ■ | | MATERIAL | SETTING |
| CAST IRON | HIGH STRENGTH IRON | 90° TAPPED 125# FLG | BRONZE | HARDENED STEEL | STEEL | VITON | CARBON FIBER | C.W. | DUCTILE IRON | 75 PSI [5 BAR] |

Standard Models

G H S 1 DC 3 - B
 GEAR DUTY DESIGN PORT SIZE HYDRAULIC SEAL STYLE
 SIZE SIZE

| MODEL NUMBER | NOM. CAPACITY - SPEED | | | | MAXIMUM | | | | SHIPPING DATA | |
|--|-----------------------|-------------------------|--------------|--------------------------------------|---------------------------------|------------------------------|---------------------------------------|--------------|-----------------------|----------------------|
| | MAXIMUM | | ALTERNATIVE | | DIFFERENTIAL PRESSURE-PSI [BAR] | | | TEMP. | Weight LBS [KG] | Volume CU. FT. |
| | GPM [LPM] | RPM 60 Hz [50 HZ] | GPM [LPM] | RPM ^② 60 Hz [50 HZ] | BELOW 38 SSU [4 cSt] | 38 TO 100 SSU [21 cSt] | 100 TO 250,000 SSU [55,000 cSt] | °F [°C] | | |
| GHS 1DC 3-B ● ① GHS 1DC 4-B ■ ① | 9 [28] | | 6 [19] | | | | | | 30 [13,6] | 2.9 |
| GHS 1DE 3-B ● ① GHS 1DE 4-B ■ ① | 11 [35] | | 7 [22] | | | | | | 30 [13,6] | 2.9 |
| GHS 1-1/2 GC 3-B ● GHS 1-1/2 GC 4-B ■ | 16 [50] | | 10 [32] | | | | | | 54 [24,5] | 2.9 |
| GHS 2 GC 3-B ● GHS 2 GC 4-B ■ | | | | | | | 300 [20.7] | | 54 [24,5] | 2.9 |
| GHS 1-1/2 GF 3-B ● GHS 1-1/2 GF 4-B ■ | 23 [73] | 1750 [1460] | 15 [47] | 1150 [960] | | | | 400 [204] | 54 [24,5] | 2.9 |
| GHS 2 GF 3-B ● GHS 2 GF 4-B ■ | | | | | 100 [7] | 150 [10] | | | 54 [24,5] | 2.9 |
| GHS 1-1/2 GH 3-B ● GHS 1-1/2 GH 4-B ■ | 31 [98] | | 20 [63] | | | | | | 54 [24,5] | 2.9 |
| GHS 2 GH 3-B ● GHS 2 GH 4-B ■ | | | | | | | | | 54 [24,5] | 2.9 |
| GHS 1-1/2 GJ 3-B ● ③ GHS 1-1/2 GJ 4-B ■ ③ | 38 [120] | | 25 [79] | | | | | | 54 [24,5] | 2.9 |
| GHS 2 GJ 3-B ● ③ GHS 2 GJ 4-B ■ ③ | | | | | | | 200 [14] | 500 [260] | 54 [24,5] | 2.9 |
| GHS 2 JG 3-B ● GHS 2 JG 4-B ■ | | | | | | | | | 125 [57] | 5.3 |
| GHS 2-1/2 JG 3-B ● GHS 2-1/2 JG 4-B ■ | 40 [126] | 1150 [960] | 30 [95] | 870 [725] | | | 300 [20.7] | | 125 [57] | 5.3 |
| GHS 3 JG 3-B ● GHS 3 JG 4-B ■ | | | | | | | | | 125 [57] | 5.3 |

STANDARD MODELS CONT.

NOTE: RECOMMENDED PORT SIZES ARE SHOWN IN **BOLDFACE**. EXAMPLE: **GHS 2JG 3-B**

- MECHANICAL SEAL
- LIPSEAL/PACKING

- ① 3450 [2875] RPM PERMISSIBLE TO 1,000 SSU [220 Cts.] AND 100 PSI [7 BAR]
- ② MAXIMUM SPEED FOR AMMONIA MODELS.
- ③ PUMP LIMITED TO 200 PSI MAXIMUM PRESSURE.

THE GORMAN-RUPP COMPANY • MANSFIELD, OHIO
GORMAN-RUPP OF CANADA LIMITED • ST. THOMAS, ONTARIO, CANADA

Standard Models Cont'd

| MODEL NUMBER | NOM. CAPACITY - SPEED | | | | MAXIMUM | | | | SHIPPING DATA | |
|--|-----------------------|-------------------------|--------------|--------------------------------------|---------------------------------|------------------------------|---------------------------------------|-------------------|--------------------|-------------------|
| | MAXIMUM | | ALTERNATIVE | | DIFFERENTIAL PRESSURE-PSI [BAR] | | | TEMP. | Weight LBS [KG] | Volume CU. FT. |
| | GPM [LPM] | RPM 60 Hz [50 HZ] | GPM [LPM] | RPM ^① 60 Hz [50 HZ] | BELOW 38 SSU [4 cSt] | 38 TO 100 SSU [21 cSt] | 100 TO 250,000 SSU [55,000 cSt] | °F [°C] | | |
| GHS 2 JJ 3-B ● GHS 2 JJ 4-B ■ | 56 [177] | 1150 [960] | 42 [133] | 870 [725] | 100 [7] | 150 [10] | 300 ^③ [20.7] | ● 400 [204] | 125 [57] | 5.3 |
| GHS 2-1/2 JJ 3-B ● GHS 2-1/2 JJ 4-B ■ | | | | | | | | | 125 [57] | 5.3 |
| GHS 3 JJ 3-B ● GHS 3 JJ 4-B ■ | | | | | | | | | 125 [57] | 5.3 |
| GHS 2 JL 3-B ● GHS 2 JL 4-B ■ | 77 [243] | 1150 [960] | 58 [183] | 870 [725] | 100 [7] | 150 [10] | 300 ^③ [20.7] | ● 400 [204] | 125 [57] | 5.3 |
| GHS 2-1/2 JL 3-B ● GHS 2-1/2 JL 4-B ■ | | | | | | | | | 125 [57] | 5.3 |
| GHS 3 JL 3-B ● GHS 3 JL 4-B ■ | | | | | | | | | 125 [57] | 5.3 |
| GHS 2 JP 3-B ● GHS 2 JP 4-B ■ ② | 107 [338] | 1150 [960] | 81 [256] | 870 [725] | 100 [7] | 150 [10] | 200 [14] | ● 400 [204] | 125 [57] | 5.3 |
| GHS 2-1/2 JP 3-B ● GHS 2-1/2 JP 4-B ■ ② | | | | | | | | | 125 [57] | 5.3 |
| GHS 3 JP 3-B ● GHS 3 JP 4-B ■ ② | | | | | | | | | 125 [57] | 5.3 |
| GHS 1-1/2 NK 3-B ● GHS 1-1/2 NK 4-B ■ | 99 [375] | 960 [960] | 60 [189] | 580 [480] | 100 [7] | 150 [10] | 300 ^③ [20.7] | ■ 500 [260] | 167 [75,7] | 5.3 |
| GHS 2 NK 3-B ● GHS 2 NK 4-B ■ | | | | | | | | | 167 [75,7] | 5.3 |
| GHS 2-1/2 NK 3-B ● GHS 2-1/2 NK 4-B ■ | | | | | | | | | 167 [75,7] | 5.3 |
| GHS 3 NK 3-B ● GHS 3 NK 4-B ■ | 132 [500] | 960 [960] | 80 [252] | 580 [480] | 100 [7] | 150 [10] | 300 ^③ [20.7] | ■ 500 [260] | 167 [75,7] | 5.3 |
| GHS 2 NM 3-B ● GHS 2 NM 4-B ■ | | | | | | | | | 167 [75,7] | 5.3 |
| GHS 2-1/2 NM 3-B ● GHS 2-1/2 NM 4-B ■ | | | | | | | | | 167 [75,7] | 5.3 |
| GHS 3 NM 3-B ● GHS 3 NM 4-B ■ | 165 [624] | 960 [960] | 99 [312] | 580 [480] | 100 [7] | 150 [10] | 200 [14] | ■ 500 [260] | 167 [75,7] | 5.3 |
| GHS 2 NP 3-B ● GHS 2 NP 4-B ■ ② | | | | | | | | | 167 [75,7] | 5.3 |
| GHS 2-1/2 NP 3-B ● GHS 2-1/2 NP 4-B ■ ② | | | | | | | | | 167 [75,7] | 5.3 |
| GHS 3 NP 3-B ● GHS 3 NP 4-B ■ ② | 165 [624] | 960 [960] | 99 [312] | 580 [480] | 100 [7] | 150 [10] | 200 [14] | ■ 500 [260] | 167 [75,7] | 5.3 |
| GHS 2 NP 3-B ● GHS 2 NP 4-B ■ ② | | | | | | | | | 167 [75,7] | 5.3 |
| GHS 2-1/2 NP 3-B ● GHS 2-1/2 NP 4-B ■ ② | | | | | | | | | 167 [75,7] | 5.3 |

STANDARD MODELS CONT.

NOTE: RECOMMENDED PORT SIZES ARE SHOWN IN **BOLDFACE**. EXAMPLE: GHS 2JG 3-B

- ① MAXIMUM SPEED FOR AMMONIA MODELS.
- ② PUMP LIMITED TO 200 PSI MAXIMUM PRESSURE.
- ③ FOR 200-300 PSI OPERATION, HOUSING BUSHING IS RECOMMENDED. CONSULT BUSHING LIMITATION TABLE OR CONSULT FACTORY.

- MECHANICAL SEAL
- LIPSEAL/PACKING

THE GORMAN-RUPP COMPANY • MANSFIELD, OHIO
 GORMAN-RUPP OF CANADA LIMITED • ST. THOMAS, ONTARIO, CANADA

| MODEL NUMBER | NOM. CAPACITY - SPEED | | | | MAXIMUM | | | | SHIPPING DATA | |
|--|-----------------------|-------------------------|--------------|--------------------------------------|-----------------------------------|------------------------------|---------------------------------------|-------------------|---------------|--------|
| | MAXIMUM | | ALTERNATIVE | | DIFFERENTIAL PRESSURE - PSI [BAR] | | | TEMP. | Weight | Volume |
| | GPM [LPM] | RPM 60 Hz [50 HZ] | GPM [LPM] | RPM ^① 60 Hz [50 HZ] | BELOW 38 SSU [4 cSt] | 38 TO 100 SSU [21 cSt] | 100 TO 250,000 SSU [55,000 cSt] | °F [°C] | | |
| GHS 2 RM 3-B ● GHS 2 RM 4-B ■ | 172 [542] | 720 [600] | 115 [362] | 480 [400] | 100 [7] | 150 [10] | 300 [20.7] | ● 400 [204] | 301 | 10.7 |
| GHS 2-1/2 RM 3-B ● † GHS 2-1/2 RM 4-B ■ † | | | | | | | | | [136] | 10.7 |
| GHS 3 RM 3-B ● † GHS 3 RM 4-B ■ † | | | | | | | | | [136] | 10.7 |
| GHS 4 RM 3-B ● † GHS 4 RM 4-B ■ † | | | | | | | | | [136] | 10.7 |
| GHS 2-1/2 RP 3-B ● † GHS 2-1/2 RP 4-B ■ † | 215 [678] | 720 [600] | 143 [451] | 480 [400] | 100 [7] | 150 [10] | 300 [20.7] | ● 400 [204] | 301 | 10.7 |
| GHS 3 RP 3-B ● † GHS 3 RP 4-B ■ † | | | | | | | | | [136] | 10.7 |
| GHS 4 RP 3-B ● † GHS 4 RP 4-B ■ † | | | | | | | | | [136] | 10.7 |
| GHS 2-1/2 RR 3-B ● † GHS 2-1/2 RR 4-B ■ † | | | | | | | | | [136] | 10.7 |
| GHS 3 RR 3-B ● † GHS 3 RR 4-B ■ † | 255 [804] | 720 [600] | 170 [536] | 480 [400] | 100 [7] | 150 [10] | 300 [20.7] | ● 400 [204] | 301 | 10.7 |
| GHS 4 RR 3-B ● † GHS 4 RR 4-B ■ † | | | | | | | | | [136] | 10.7 |
| GHS 3 RS 3-B ● † GHS 3 RS 4-B ■ † | | | | | | | | | [136] | 10.7 |
| GHS 4 RS 3-B ● † GHS 4 RS 4-B ■ † | | | | | | | | | [136] | 10.7 |
| GHS 3 RS 3-B ● † GHS 3 RS 4-B ■ † | 295 [930] | 720 [600] | 196 [618] | 480 [400] | 100 [7] | 150 [10] | 300 [20.7] | ● 400 [204] | 301 | 10.7 |
| GHS 4 RS 3-B ● † GHS 4 RS 4-B ■ † | | | | | | | | | [136] | 10.7 |

- ① MAXIMUM SPEED FOR AMMONIA MODELS.
- ② PUMP LIMITED TO 200 PSI MAXIMUM PRESSURE

- MECHANICAL SEAL
- LIPSEAL/PACKING
- † PORTS ARE COMPATIBLE WITH 125# ANSI CAST IRON FLANGES. ALL OTHER PORTS ARE TAPPED NPT FOR ANSI PIPE. OPTIONAL [DIN] FLANGES OR TAPPED [BSP] PORTS AVAILABLE FOR EXPORT MARKET.

| APPLICATION RECOMMENDATIONS: | | |
|-------------------------------------|--|---|
| APPLICATION | OPTIONS REQUIRED (Select One From Each Row) | OPERATING LIMITATIONS |
| HIGH TEMPERATURE | 25U, 25V, OR 25W 35J – 35M (AS REQ'D) 40M, 40W 61H, OR 65Q 70F OR 70K | TEMPERATURE: 675°F MAX. PRESSURE: 200 PSI MAX. |
| AMMONIA | 25G OR 25H 40N 60K 70E 90A | PRESSURE: 200 PSI MAX. 2/3 RATED SPEED 4 FEET NPSHr |
| LP GAS | 25G OR 25H 40F OR 40N 70D OR 70E | PRESSURE: 200 PSI MAX. 3 FEET NPSHr |
| ASPHALT | 25U, 25V OR 25W 35J–35M (AS REQ'D) 40G, 40M, 40W 41R, 41W 65S 70B, 70K 71K | TEMPERATURE: 500°F MAX. |
| JACKETED | 40G, 40J, 40K, 40W, 41U, 41W 70B, 70G, 70K 71K, 71M | LIMIT JACKET PRESSURE TO 150 PSIG |

NOTE: PROPER PUMP APPLICATION REQUIRES CONSIDERATION OF ADDITIONAL FACTORS. PLEASE REVIEW APPLICATION GUIDE IN SECTION 500 OR CONSULT THE FACTORY.

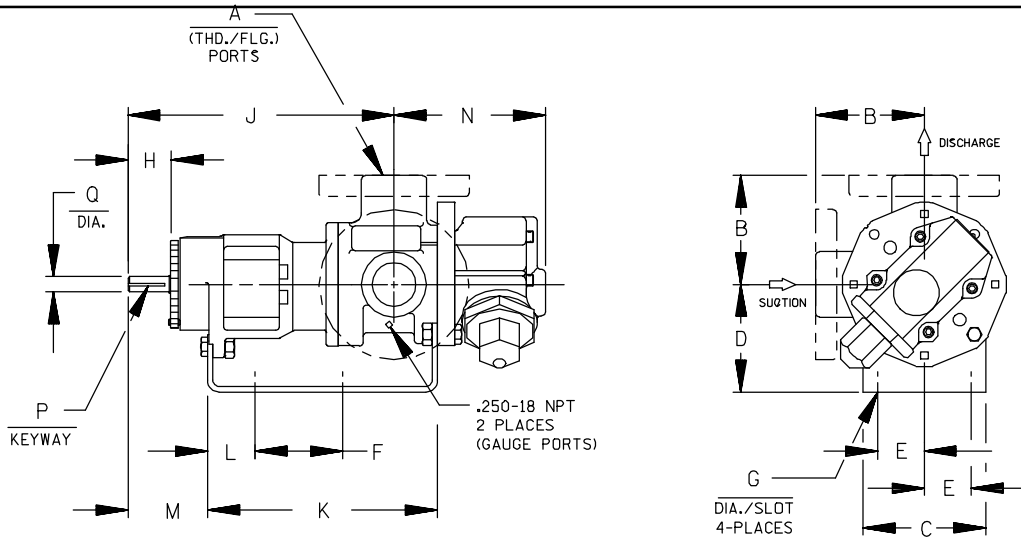

CAD FILE NO.: 16669

| MODEL NUMBERS | PUMP DIMENSIONS - INCHES [MILLIMETERS] | | | | | | | | | | | | | | |
|----------------|--|---|----------------|--|--------------|----------------|-------------|--------------|----------------|----------------|--------------|---------------|----------------|-------------------------------|--------------|
| | A | B | C | D | E | F | G | H | J | K | L | M | N | P | Q |
| GHS D | 1" | 2.50* [64] * 2.75 [70] † 3.19 [81] † 4.00 [102] † | 4.00 [102] | 3.50* [89] * 4.50 [114] 5.25 [133] | 1.62 [41] | 5.50 [140] | .41 [10] | 1.16 [30] | 8.43 [214] | 7.54 [192] | 1.09 [28] | 2.29 [58] | 4.98 [127] | .12 [3] x .75 [19] | .50 [13] |
| GHS G GHA G | 1-1/2" 2" | 3.50* [89] * 3.75 [95] † 4.00 [102] † | 4.88 [124] | 3.50* [89] * 4.50 [114] 5.25 [133] 6.25 [159] | 1.62 [41] | 8.00 [203] | .41 [10] | 1.62 [41] | 12.06 [306] | 10.72 [272] | 1.52 [39] | 3.35 [85] | 5.70 [145] | .19 [5] x 1.25 [32] | .75 [19] |
| GHS J GHA J | 2" 2-1/2" 3" | 4.50* [114] * 5.00 † [127] † 6.00 † [152] † 6.31 [160] † | 6.88 [175] | 5.25* [133] * 6.25 [159] 7.00 [178] 8.00 [203] | 2.88 [73] | 10.00 [254] | .44 [11] | 2.50 [64] | 15.68 [398] | 14.31 [363] | 2.77 [70] | 4.48 [114] | 8.50 [216] | .25 [6] x 2.00 [51] | 1.00 [25] |
| GHS N GHA N | 1-1/2" 2" 2-1/2" 3" | 5.12* [130] * 5.25 [133] † 7.19 † [183] † | 8.00 [203] | 4.50 [114] 5.25* [133] * 6.25 [159] 7.00 [178] 8.00 [203] | 2.88 [73] | 10.00 [254] | .44 [11] | 2.58 [66] | 17.45 [443] | 15.14 [385] | 2.69 [68] | 4.56 [116] | 7.59 [193] | .25 [6] x 2.00 [51] | 1.12 [32] |
| GHS R GHA R | 2" 2-1/2" 3" 4" | 6.50* [165] * 7.19 † [183] † | 10.50 [267] | 7.00 [178] | 3.75 [95] | 13.75 [349] | .52 [13] | 2.25 [57] | 17.87 [454] | 17.36 [441] | 1.86 [47] | 4.70 [119] | 11.31 [287] | .38 [10] x 1.88 [48] | 1.44 [37] |

† PORTS ARE COMPATIBLE WITH 125* OR 250* ANSICAST IRON FLANGES. ALL OTHER PORTS ARE TAPPED NPT FOR ANSIPIPE. OPTIONAL (DIN) FLANGES OR TAPPED (BSP) PORTS AVAILABLE FOR EXPORT MARKET.
* STANDARD DIMENSION † 180° HOUSING

THE GORMAN-RUPP COMPANY • MANSFIELD, OHIO
GORMAN-RUPP OF CANADA LIMITED • ST. THOMAS, ONTARIO, CANADA



GHS & GHA

DIRECT FLEX DRIVE OPTION DIMENSIONS



| PUMP MODEL | PUMP DIMENSIONS - INCHES[MILLIMETERS] | | | | | | | | | | | | | |
|----------------|---------------------------------------|-----------------|-----------------|-----------------|---------------|----------------|----------------|----------------|----------------|----------------|----------------|-----------------|---------------|---------------|
| | A | MOTOR FRAME | B | C | D | E | F | G | H | J | K | L | M | N |
| GHS D | 1" | 56/56H | 2.50* [64] | 2.00 [51] | 3.50* [89] | 4.44 [113] | 8.88 [226] | 10.14 [258] | | 20.29 [515] | 19.25 [489] | 25.25 [641] | 3.00 [76] | 4.97 [126] |
| | | 143T/145T | 2.75 † [70] | 4.00 [102] | 4.50 [114] | 7.75 [197] | 15.50 [394] | 17.50 [445] | .56 [14] | 26.66 [677] | 23.50 [597] | 33.50 [851] | 5.00 [127] | |
| | | 182T/184T | 3.19 † [81] | | | | | | | | | | | |
| | | 213T/215T | 4.00 † [102] | | | | | | | | | | | |
| GHS G GHA G | 1- 1/2" | 56/56H | 3.50* [89] | 2.00 [51] | 3.50* [89] | 4.44 [113] | 8.88 [226] | 10.14 [258] | | 19.93 [506] | 19.25 [489] | 25.25 [641] | 3.00 [76] | 5.70 [145] |
| | | 143T/145T | 3.75 † [95] | | | | | | | | | | | |
| | 182T/184T | 4.00 [102] | | 4.50 [114] | 7.75 [197] | 15.50 [394] | 17.50 [445] | .56 [14] | 26.30 [668] | 23.50 [597] | 33.50 [851] | 5.00 [127] | | |
| | 213T/215T | | | | | | | | | | | | 5.25 [133] | |
| 254T/256T | 4.00 † [102] | 6.25 [159] | | | | | | | | | | | | |
| GHS J GHA J | 2" | 182T/184T | 4.50* [114] | 4.00 [102] | 4.50 [114] | 9.50 [241] | 19.00 [483] | 21.00 [533] | | 36.28 [922] | 35.50 [902] | 45.50 [1156] | 5.00 [127] | 8.49 [216] |
| | | 213T/215T | 5.00 † [127] | | | | | | | | | | | |
| | 2- 1/2" | 254T/256T | 6.00 † [152] | | | | | | | | | | | |
| | | 284T/286T | 6.00 † [152] | | | | | | | | | | | |
| 3" | 324T/326T | 6.31 † [160] | 8.00 [203] | | | | | | | | | | | |
| | GHS N GHA N | 1- 1/2" | 182T/184T | 5.12* [130] | 4.50 [114] | 9.50 [241] | 19.00 [483] | 21.00 [533] | | 36.87 [936] | 35.50 [902] | 45.50 [1156] | 5.00 [127] | 8.70 [221] |
| 2" | | 213T/215T | 5.25* [133] | | | | | | | | | | | |
| | | 2- 1/2" | 254T/256T | 5.25 † [133] | 6.25 [159] | | | | | | | | | |
| 3" | | | 284T/286T | 7.19 † [183] | 7.00 [178] | 8.00 [203] | 37.98 [965] | 7.59 [193] | | | | | | |

* STANDARD DIMENSION

† PORTS ARE COMPATIBLE WITH 125# OR 250# ANSICAST IRON FLANGES. ALL OTHER PORTS ARE TAPPED NPT FOR ANSIPIPE. OPTIONAL (DIN) FLANGES OR TAPPED (BSP) PORTS AVAILABLE FOR EXPORT MARKET.

† 180° HOUSING

GHS & GHA

DIRECT FLEX DRIVE OPTIONS

(Drive Assembly Number Includes Base, Coupling & Guard, But **NOT** the Motor)



| PUMP MODEL NUMBER | RPM | FRAME | MTG. FT. OPTION REQ. | DRIVE ASSY NO. |
|--------------------------|-----------------------------|-----------|----------------------|----------------|
| GHS GHA D | 3450 1750 1150 850 | 56/56H | STD | 90451-086 |
| | | 143T/145T | STD | 90451-018 |
| | | 182T/184T | 80F | 90451-058 |
| | | 213T/215T | 80J | 90451-062 |
| GHS GHA G | 1750 1150 850 | 56/56H | STD | 90451-160 |
| | | 143T/145T | STD | 90451-162 |
| | | 182T/184T | 80F | 90451-168 |
| | | 213T/215T | 80J | 90451-176 |
| | | 254T | 80P | 90451-180 |
| GHS GHA J | 1150 850 | 182T/184T | 80F | 90451-260 |
| | | 213T/215T | STD | 90451-264 |
| | | 254T/256T | 80P | 90451-272 |
| | | 284T/286T | 80S | 90451-280 |
| | | 324T/326T | 80V | 90451-288 |
| GHS GHA N | 850 | 254T/256T | 80P | 90451-390 |
| | | 284T/286T | 80S | 90451-398 |
| | | 324T/326T | 80V | 90451-406 |

NOTE: CONSULT FACTORY FOR;
 1. HORSEPOWERS & FRAMES NOT SHOWN
 2. DRIP PAN BASES



GHS & GHA

GRR REDUCER C-FLANGE FLEX DRIVE OPTION DIMENSIONS (56C - 215TC Frame Size Range)



CAD FILE NO.: 16551

| PUMP MODEL | PUMP DIMENSIONS - INCHES[MILLIMETERS] | | | | | | | | | | | | | | |
|----------------|---------------------------------------|-------------|-----------------|--------------|---------------|---------------|----------------|----------------|-------------|----------------|----------------|-----------------|--------------|---------------|-------------|
| | A | MOTOR FRAME | B | C | D | E | F | G | H | J | K | L | M | N | |
| GHS D | 1" | 56C | 2.50* [64] | 2.00 [51] | 3.50* [89] | 4.41 [112] | 13.00 [330] | 15.00 [381] | .56 [14] | 26.58 [675] | 25.50 [648] | 31.50 [800] | 3.00 [76] | 4.98 [126] | |
| | | 143TC/145TC | 2.75 † [70] | | | | | | | | | | | | |
| | | 184C | 3.19 † [81] | | | | | | | | | | | | |
| | | 182TC/184TC | 4.00 † [82] | | | | | | | | | | | | |
| GHS G GHA G | 1- 1/2" | 56C | 3.50* [89] | 2.00 [51] | 3.50* [89] | 4.41 [112] | 13.00 [330] | 15.00 [381] | .56 [14] | 26.22 [667] | 25.50 [648] | 31.50 [800] | 3.00 [76] | 5.72 [145] | |
| | | 143TC/145TC | 3.75 † [95] | | | | | | | | | | | | |
| | 2" | 182TC/184TC | 4.00 † [102] | | | | | | | | | | | | |
| | | 213TC/215TC | 5.25 [133] | | | | | | | | | | | | |
| GHS J GHA J | 2" | 182TC/184TC | 4.50* [114] | 2.00 [51] | 4.50 [114] | 5.50 [140] | 14.62 [372] | 16.62 [422] | .56 [14] | 35.96 [913] | 37.25 [946] | 43.25 [1098] | 3.00 [76] | 8.50 [216] | |
| | 2- 1/2" | 213TC/215TC | 5.00 † [127] | | | | | | | | | | | | |
| | | | 6.00 † [152] | | | | | | | | | | | | |
| GHS N GHA N | 1- 1/2" | 182TC/184TC | 5.12* [130] | 2.00 [51] | 4.50 [114] | 5.50 [140] | 14.62 [372] | 16.62 [422] | .56 [14] | 36.88 [931] | 37.25 [946] | 43.25 [1098] | 3.00 [76] | 8.71 [221] | |
| | 2" | | 5.25 [133] | | | | | | | | | | | | |
| | | | 2- 1/2" | | | | | | | | | | | | 213TC/215TC |
| | 3" | | | | | | | | | | | | | | |

* STANDARD DIMENSION

† PORTS ARE COMPATIBLE WITH 125* OR 250* ANSI/AST IRON FLANGES. ALL OTHER PORTS ARE TAPPED NPT FOR ANSI PIPE. OPTIONAL (DIN) FLANGES OR TAPPED (BSP) PORTS AVAILABLE FOR EXPORT MARKET.

† 180° HOUSING



GHS & GHA

GRR REDUCER C-FLANGE FLEX DRIVE OPTION DIMENSIONS (213TC - 326TC Frame Size Range)



CAD FILE NO. : 16640

| PUMP MODEL | MOUNTING DIMENSIONS | | | | | | | | | | | | | | | | |
|------------|---------------------|----------------------------|-----------------|---------------|---------------|----------------|----------------|----------------|-------------|----------------|-----------------|-----------------|-----------------|-----------------|-----------------|----------------|----------------|
| | A | MOTOR FRAME | B | C | D | E | F | G | H | J | K | L | M | N | P | R | |
| GHS J | 2" | 213TC/215TC | 4.50 * [114] | | | | | | | | | | | | | | |
| | | 254TC/256TC | 5.00 † [127] | | | | | | | | 7.59 * [193] | | 41.58 [1056] | 23.00 [584] | 56.00 [1422] | 18.14 [461] | 10.58 [269] |
| GHA J | 2 1/2" | 254TC/256TC | 6.00 † [152] | 6.00 [152] | 6.25 [159] | 10.12 [257] | 20.25 [514] | 22.50 [572] | .69 [18] | | 5.00 [127] | | | | | | |
| | | 284TC/286TC | 6.31 † [160] | | | | | | | | 8.70 [221] | | 47.00 [1194] | 25.75 [654] | 61.50 [1562] | 20.91 [531] | 10.66 [271] |
| GHS N | 2" | 213TC/215TC | 5.12 * [130] | | | | | | | | | | | | | | 18.14 [461] |
| | | 254TC/256TC | 5.25 † [130] | 6.00 [152] | 6.25 [159] | 10.12 [257] | 20.25 [514] | 22.50 [572] | .69 [18] | | 5.00 [127] | | | | | | 15.75 [400] |
| GHA N | 2 1/2" | 254TC/256TC | 7.19 † [183] | | | | | | | 8.70 [221] | | 47.69 [1211] | 25.75 [654] | 61.50 [1562] | | | 20.91 [531] |
| | | 284TC/286TC | | | | | | | | | | | | | | | |
| GHS R | 2 1/2" | 182TC/184TC 213TC/215TC | 6.50 [165] | | | | | | | | | | 38.95 [989] | 22.62 [575] | 55.25 [1403] | 19.86 [504] | 12.66 [322] |
| | | 213TC/215TC 254TC/256TC | 7.19 † [183] | 8.00 [203] | 7.00 [178] | 10.38 [264] | 20.75 [527] | 23.00 [584] | .69 [18] | 11.31 [287] | 5.00 [127] | | 44.25 [1124] | 25.28 [642] | 60.56 [1538] | 20.26 [515] | 12.39 [315] |
| | | 254TC/256TC 284TC/286TC | | | | | | | | | | | 49.20 [1250] | 27.75 [705] | 65.50 [1664] | 23.58 [585] | 12.50 [318] |
| GHA R | 3" | 284TC/286TC | 6.50 [165] | | | | | | | | | | 53.01 [1346] | 29.75 [756] | 68.50 [1756] | 25.94 [659] | 12.50 [318] |
| | | 324TC/326TC | 7.19 † [183] | 7.00 [178] | 7.00 [178] | 10.38 [264] | 22.75 [578] | 25.00 [635] | .69 [18] | 11.31 [287] | 5.00 [127] | | 57.95 [1472] | 32.12 [816] | 74.25 [1886] | 28.44 [717] | 13.50 [343] |
| | | 284TC/286TC | | | | | | | | | | | | | 74.25 [1886] | 26.44 [667] | 13.50 [343] |

STANDARD DIMENSION
 † PORTS ARE COMPATIBLE WITH 125* OR 250* ANSICAST IRON FLANGES. ALL OTHER PORTS ARE TAPPED NPT FOR ANSI PIPE. OPTIONAL (DIN) FLANGES OR TAPPED (BSP) PORTS AVAILABLE FOR EXPORT MARKET.
 † 180° HOUSING

GRR REDUCER C-FLANGE FLEX DRIVE OPTIONS

(Drive Assy Number Includes Base, Coupling, Guard & Gear Reducer, But **NOT** the Motor)



| PUMP MODEL NUMBER | PUMP RPM @1750 | PUMP RPM @1150 | REDUCER ① | | FRAME | MTG. FT. OPTION | DRIVE ASSY NO. |
|-------------------|----------------|----------------|-----------|-------------|-------------|-----------------|----------------|
| | | | RATIO | MAX.HP | | | |
| GHS GHA D | 875 | 575 | 2.00:1 | 5.65 | 56C | STD | 90453-510 |
| | | | | 11.70 | 143TC/145TC | STD | 90453-516 |
| | | | | 11.70 | 182C/184C | 80F | 90453-519 |
| | | | | 13.01 | 182TC/184TC | 80F | 90453-526 |
| | 580 | 383 | 3.00:1 | 3.76 | 56C | STD | 90453-530 |
| | | | | 8.10 | 143TC/145TC | STD | 90453-533 |
| | | | | 8.10 | 182C/184C | 80F | 90453-539 |
| | | | | 10.62 | 182TC/184TC | 80F | 90453-546 |
| | 440 | 288 | 4.00:1 | 2.82 | 56C | STD | 90453-550 |
| | | | | 5.90 | 143TC/145TC | STD | 90453-553 |
| | | | | 5.90 | 182C/184C | 80F | 90453-562 |
| | | | | 7.24 | 182TC/184TC | 80F | 90453-566 |
| | 350 | 230 | 5.00:1 | 2.26 | 56C | STD | 90453-570 |
| | | | | 5.20 | 143TC/145TC | STD | 90453-573 |
| | | | | 5.20 | 182C/184C | 80F | 90453-582 |
| | | | | 5.98 | 182TC/184TC | 80F | 90453-586 |
| GHS GHA G | 875 | 575 | 2.00:1 | 5.65 | 56C | STD | 90453-610 |
| | | | | 11.70 | 143TC/145TC | STD | 90453-613 |
| | | | | 11.70 | 182C/184C | 80F | 90453-622 |
| | | | | 13.01 | 182TC/184TC | 80F | 90453-626 |
| | 580 | 383 | 3.00:1 | 3.76 | 56C | STD | 90453-630 |
| | | | | 8.10 | 143TC/145TC | STD | 90453-633 |
| | | | | 8.10 | 182C/184C | 80F | 90453-642 |
| | | | | 10.62 | 182TC/184TC | 80F | 90453-646 |
| | 440 | 288 | 4.00:1 | 10.62 | 213TC/215TC | 80J | 90453-648 |
| | | | | 2.82 | 56C | STD | 90453-660 |
| | | | | 5.90 | 143TC/145TC | STD | 90453-663 |
| | | | | 5.90 | 182C/184C | 80F | 90453-672 |
| | 350 | 230 | 5.00:1 | 7.24 | 182TC/184TC | 80F | 90453-676 |
| | | | | 7.24 | 213TC | 80J | 90453-677 |
| | | | | 2.26 | 56C | STD | 90453-690 |
| | | | | 5.20 | 143TC/145TC | STD | 90453-693 |
| | | | 5.20 | 182C/184C | 80F | 90453-702 | |
| | | | 5.98 | 182TC/184TC | 80F | 90453-706 | |
| | | | 5.98 | 213TC | 80J | 90453-708 | |
| | | | | | | | |

(CONT'D)

① Listed reducer horsepower rated for Standard Service (8-10 hrs/day). For Light Service (3-5 hrs/day) multiply maximum rated horsepower by 1.1. For Heavy Service (16-24 hrs/day) multiply maximum rated horsepower by 0.9.

② Based on 1750 RPM input.

NOTE: CONSULT FACTORY FOR;

1. HORSEPOWERS & FRAMES NOT SHOWN
2. DRIP PAN BASES



GHS & GHA

SEC. 545

PAGE 21

January 2010

GRR REDUCER C-FLANGE FLEX DRIVE OPTIONS

(Drive Assy Number Includes Base, Coupling, Guard & Gear Reducer, But **NOT** the Motor)

| PUMP MODEL NUMBER | PUMP RPM @1750 | PUMP RPM @1150 | REDUCER ① | | FRAME | MTG. FT. OPTION | DRIVE ASSY NO. |
|--------------------------|----------------|----------------|-----------|-------------|-------------|-----------------|----------------|
| | | | RATIO | MAX.HP | | | |
| GHS GHA J | 875 | 575 | 2.00:1 | 13.01 | 182TC/184TC | 80F | 90453-722 |
| | | | | 13.01 | 213TC/215TC | STD | 90453-726 |
| | | | | 36.29 | 254TC/256TC | 80P | 90453-728 |
| | | | | 36.29 | 284TC/286TC | 80P | 90453-732 |
| | 580 | 383 | 3.00:1 | 10.62 | 182TC/184TC | 80F | 90453-737 |
| | | | | 10.62 | 213TC/215TC | 80J | 90453-741 |
| | 555 | 365 | 3.15:1 | 25.76 | 254TC/256TC | 80P | 90453-743 |
| | | | | 42.96 | 284TC/286TC | 80P | 90453-746 |
| | 440 | 288 | 4.00:1 | 7.24 | 182TC/184TC | 80F | 90453-752 |
| | | | | 7.24 | 213TC | 80J | 90453-754 |
| | 350 | 230 | 5.00:1 | 5.98 | 182TC/184TC | 80F | 90453-769 |
| | | | | 5.98 | 213TC | STD | 90453-769 |
| | | | | 16.01 | 215TC | 80P | 90453-774 |
| | | | | 30.49 | 254TC/256TC | 80J | 90453-778 |
| | 278 | 183 | 6.30:1 | 5.94 | 182TC/184TC | | 90453-850 |
| | | | | 13.36 | 213TC/215TC | 80F | 90453-852 |
| | | | | 23.43 | 254TC/256TC | | 90453-853 |
| | 219 | 144 | 8.00:1 | 9.47 | 182TC/184TC | 80F | 90453-856 |
| 18.48 | | | | 213TC/215TC | 80F | 90453-857 | |
| 18.48 | | | | 254TC/256TC | | 90453-858 | |
| GHS GHA N | 875 | 575 | 2.00:1 | 13.01 | 184TC | 80F | 90453-795 |
| | | | | 13.01 | 213TC/215TC | STD | 90453-799 |
| | | | | 36.29 | 254TC/256TC | 80P | 90453-801 |
| | | | | 36.29 | 284TC/286TC | 80P | 90453-805 |
| | 580 | 383 | 3.00:1 | 8.10 | 143T/145T | STD | 90453-806 |
| | | | | 10.62 | 182TC/184TC | 80F | 90453-810 |
| | | | | 10.62 | 213TC/215TC | STD | 90453-812 |
| | 555 | 365 | 3.15:1 | 25.76 | 254TC/256TC | 80P | 90453-817 |
| | | | | 42.96 | 284TC/286TC | 80P | 90453-821 |
| | 440 | 288 | 4.00:1 | 7.24 | 184TC | 80F | 90453-825 |
| | | | | 7.24 | 213TC | STD | 90453-827 |
| | 350 | 230 | 5.00:1 | 5.98 | 182TC/184TC | 80F | 90453-840 |
| | | | | 5.98 | 213TC | STD | 90453-842 |
| | | | | 16.01 | 215TC | STD | 90453-845 |
| | | | | 30.49 | 254TC/256TC | STD | 90453-847 |
| | 278 | 183 | 6.30:1 | 5.94 | 182TC/184TC | | 90453-950 |
| | | | | 13.36 | 213TC/215TC | 80F | 90453-952 |
| | | | | 23.43 | 254TC/256TC | | 90453-953 |
| 219 | 144 | 8.00:1 | 9.47 | 182TC/184TC | 80F | 90453-956 | |
| | | | 18.48 | 213TC/215TC | 80F | 90453-957 | |
| | | | 18.48 | 254TC/256TC | | 90453-958 | |

(CONT'D)

① Listed reducer horsepower rated for Standard Service (8-10 hrs/day). For Light Service (3-5 hrs/day) multiply maximum rated horsepower by 1.1. For Heavy Service (16-24 hrs/day) multiply maximum rated horsepower by 0.9.

② Based on 1750 RPM input.

NOTE: CONSULT FACTORY FOR;

1. HORSEPOWERS & FRAMES NOT SHOWN
2. DRIP PAN BASES



GHS & GHA

SEC. 545

PAGE 22

January 2010

GRR REDUCER C-FLANGE FLEX DRIVE OPTIONS

(Drive Assy Number Includes Base, Coupling, Guard & Gear Reducer, But **NOT** the Motor)

| PUMP MODEL NUMBER | PUMP RPM @1750 | PUMP RPM @1150 | REDUCER ① | | FRAME | MTG. FT. OPTION | DRIVE ASSY NO. |
|--------------------------|----------------|----------------|-----------|-------------|-------------|-----------------|----------------|
| | | | RATIO | MAX.HP | | | |
| GHS GHA R | 700 | 460 | 2.50:1 | 13.96 | 213TC/215TC | STD | 90453-861 |
| | | | | 30.62 | 254TC/256TC | STD | 90453-864 |
| | | | | 30.62 | 284TC/286TC | STD | 90453-869 |
| | 634 | 417 | 2.76:1 | 46.17 | 324TC/326TC | STD | 90453-874 |
| | | | | 75.00 | 364TC | STD | 90453-878 |
| | 555 | 365 | 3.15:1 | 10.10 | 213TC/215TC | STD | 90453-884 |
| | | | | 25.76 | 254TC/256TC | STD | 90453-886 |
| | | | | 42.96 | 284TC/286TC | STD | 90453-893 |
| | 530 | 348 | 3.38:1 | 66.20 | 324TC/326TC | STD | 90453-898 |
| | 438 | 288 | 4.00:1 | 9.42 | 184TC | STD | 90453-901 |
| | | | | 20.00 | 213TC/215TC | STD | 90453-904 |
| | | | | 38.16 | 254TC/256TC | STD | 90453-911 |
| | | | | 38.16 | 284TC/286TC | STD | 90453-916 |
| | 420 | 278 | 4.13:1 | 54.4 | 324TC/326TC | STD | 90453-918 |
| | 350 | 230 | 5.00:1 | 6.10 | 184TC | STD | 90453-921 |
| | | | | 16.01 | 213TC/215TC | STD | 90453-926 |
| | | | | 30.49 | 254TC/256TC | STD | 90453-929 |
| | | | | 30.49 | 284TC/286TC | STD | 90453-933 |
| | 278 | 184 | 6.30:1 | 5.94 | 184TC | STD | 90453-940 |
| | | | | 13.36 | 213TC/215TC | STD | 90453-941 |
| 23.43 | | | | 254TC/256TC | STD | 90453-942 | |
| 219 | 145 | 8.00:1 | 9.47 | 184TC | STD | 90453-944 | |
| | | | 18.48 | 213TC/215TC | STD | 90453-946 | |
| | | | 18.48 | 254TC | STD | 90453-947 | |

① Listed reducer horsepower rated for Standard Service (8-10 hrs/day). For Light Service (3-5 hrs/day) multiply maximum rated horsepower by 1.1. For Heavy Service (16-24 hrs/day) multiply maximum rated horsepower by 0.9.

② Based on 1750 RPM input.

NOTE: CONSULT FACTORY FOR;

1. HORSEPOWERS & FRAMES NOT SHOWN
2. DRIP PAN BASES



PERFORMANCE CURVES

SPEED VS. CAPACITY/HORSEPOWER

RP Hydraulic Size

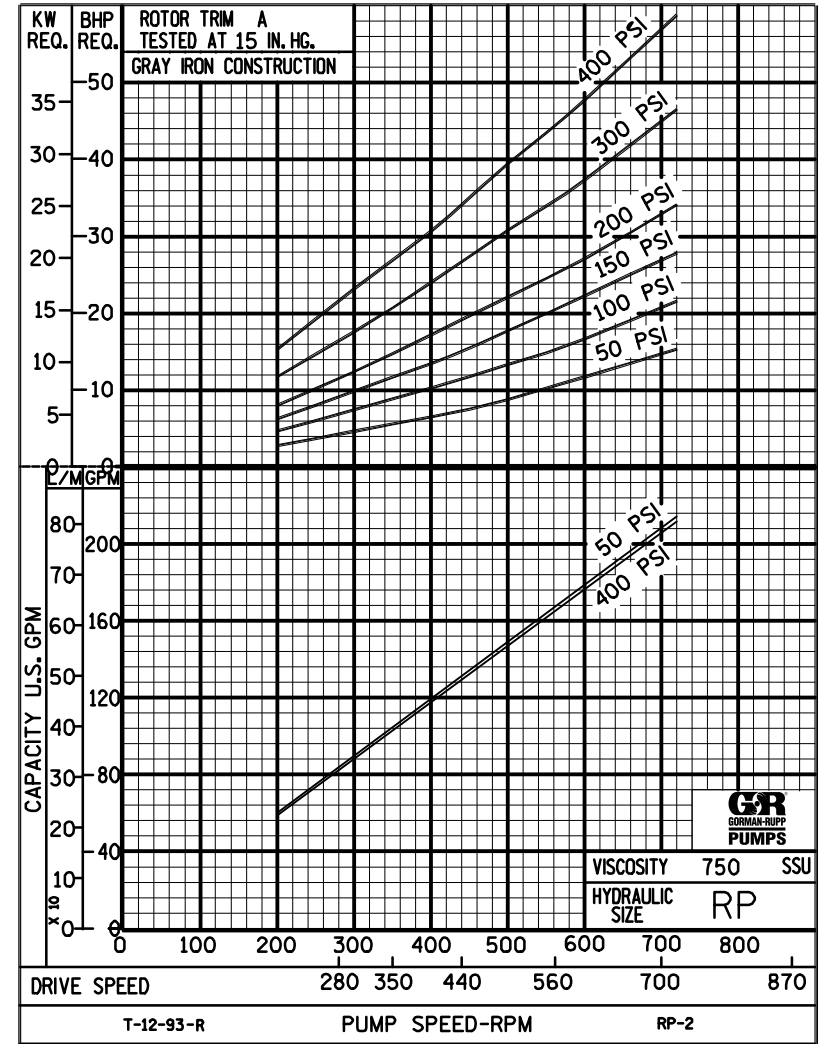
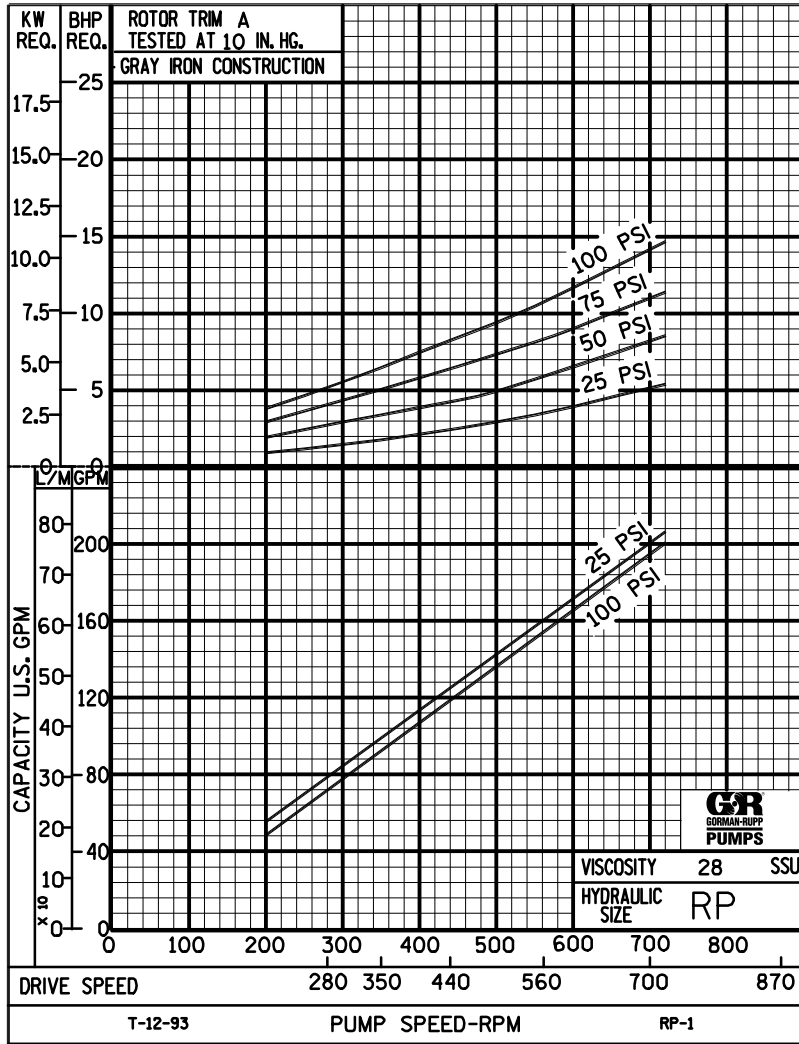

THE GORMAN-RUPP COMPANY • MANSFIELD, OHIO
 GORMAN-RUPP OF CANADA LIMITED • ST. THOMAS, ONTARIO, CANADA

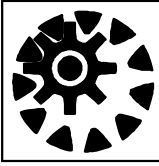

PERFORMANCE CURVES

SPEED VS. CAPACITY/HORSEPOWER

RP Hydraulic Size

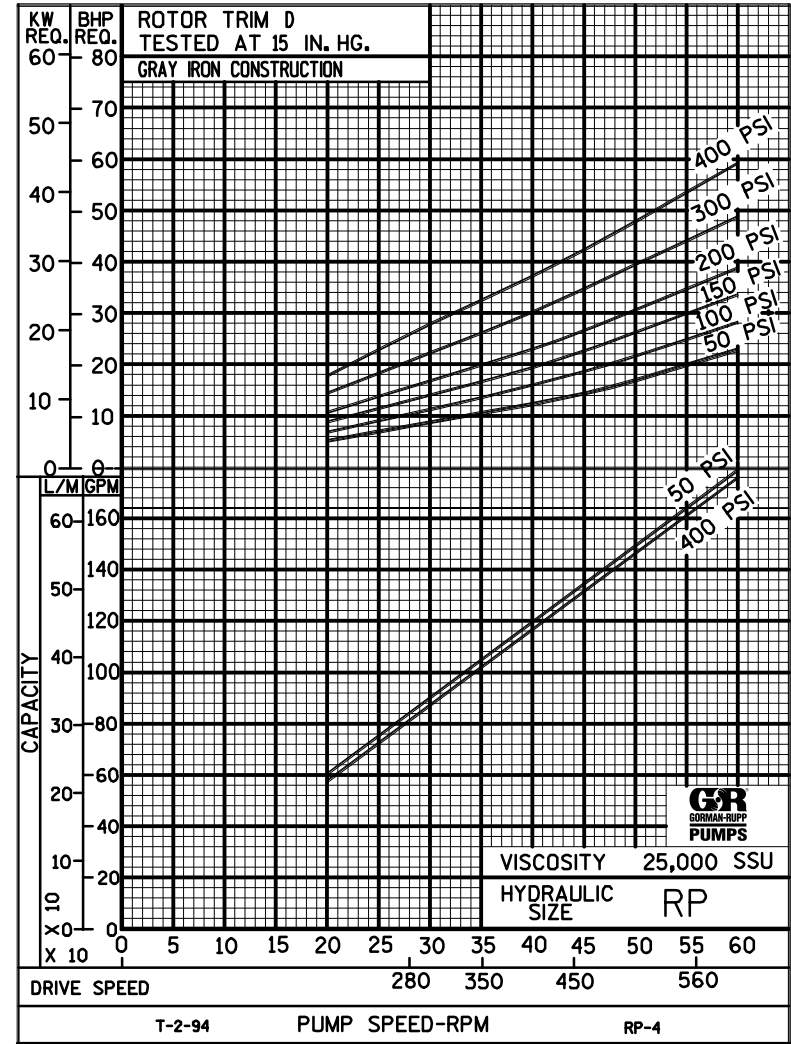
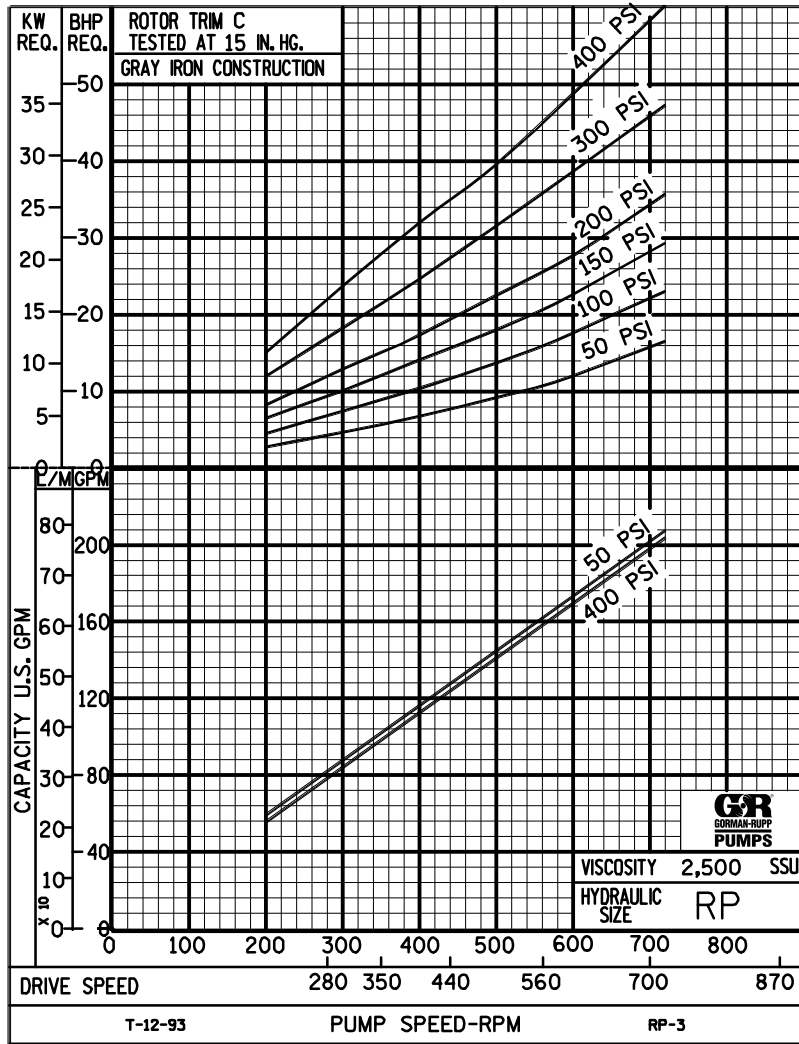

THE GORMAN-RUPP COMPANY • MANSFIELD, OHIO
GORMAN-RUPP OF CANADA LIMITED • ST. THOMAS, ONTARIO, CANADA

Printed in U.S.A.



RP

PUMP HYDRAULIC SIZE CHART

SEC. 500

Page 112

January 2010

**215 GPM
720 RPM**

| NOMINAL | | ROTOR TRIM | VISCOSITY (SSU) | N.I.P.R. (PSIA) | FRICTION PIPE LOSS (PSI/FT) <small>(Based on Sch 40 Steel Pipe)</small> | | | | | FULL BYPASS RELIEF VALVE PRESSURE (PSI) | | | | | CAPACITY (GPM) / H.P. REQUIRED | | | | | | | | | | | | | | | | | |
|----------|-----------|------------|-----------------|-----------------|--|--------|-----|-----|-----|---|-----|-----|-------------|-----|--------------------------------|-----|-----|-----|-----|-----|-----|-----|-----|-----|-----|--|--|--|--|--|--|--|
| CAP. GPM | SPEED RPM | | | | PIPE DIAMETER | | | | | CRACKING PRESS. (PSI) | | | | | DIFFERENTIAL PRESSURE (PSI) | | | | | | | | | | | | | | | | | |
| | | | | | 2" | 2 1/2" | 3" | 4" | 6" | LOW PRES R/V | | | HI PRES R/V | | HEAVY DUTY | | | | | | | | | | | | | | | | | |
| | | | | | | | 50 | 75 | 100 | 150 | 200 | 25 | 50 | 75 | 100 | 150 | 200 | 300 | 400 | | | | | | | | | | | | | |
| 215 | 720 | STD | 28 | 4.0 | .31 | .13 | .04 | .01 | - | 62 | 87 | 123 | 185 | | | 206 | 204 | 202 | 200 | | | | | | | | | | | | | |
| | | | 32 | | .33 | .13 | .04 | .01 | - | | | | | | | 5.9 | 8.1 | 12 | 15 | | | | | | | | | | | | | |
| | | | 38 | 4.0 | .35 | .14 | .05 | .01 | - | 64 | 90 | 126 | 187 | | | | | 208 | 206 | 204 | 202 | 196 | | | | | | | | | | |
| | | | 50 | | .38 | .16 | .05 | .01 | - | | | | | | | | | 7.3 | 9.3 | 13 | 16 | 23 | | | | | | | | | | |
| | | | 70 | 4.0 | .42 | .18 | .06 | .02 | - | 69 | 95 | 130 | 192 | 251 | | | | 210 | 208 | 208 | 206 | 202 | 198 | | | | | | | | | |
| | | | 100 | | .46 | .20 | .07 | .02 | - | | | | | | | | | 9.3 | 12 | 15 | 18 | 25 | 30 | | | | | | | | | |
| | | | 150 | 4.0 | .51 | .22 | .08 | .02 | - | 74 | 99 | 134 | 196 | 258 | | | | 212 | 212 | 210 | 210 | 208 | 204 | 202 | 200 | | | | | | | |
| | | | 200 | | .55 | .24 | .08 | .02 | - | | | | | | | | | 11 | 13 | 17 | 20 | 26 | 32 | 45 | 58 | | | | | | | |
| | | | 300 | 4.0 | .61 | .27 | .10 | .03 | - | 80 | 105 | 140 | 202 | 267 | | | | 214 | 212 | 212 | 212 | 210 | 208 | 206 | 206 | | | | | | | |
| | | | 500 | | .72 | .31 | .11 | .02 | - | | | | | | | | | 12 | 15 | 18 | 21 | 28 | 34 | 46 | 59 | | | | | | | |
| | | | 750 | 4.0 | .51 | .25 | .10 | .04 | .01 | 84 | 110 | 144 | 206 | 274 | | | | 214 | 214 | 214 | 214 | 214 | 212 | 212 | 212 | | | | | | | |
| | | | 1,000 | | .68 | .33 | .14 | .05 | .01 | | | | | | | | | 13 | 16 | 19 | 22 | 29 | 35 | 47 | 60 | | | | | | | |
| | | 2,000 | 4.3 | 1.35 | .66 | .28 | .09 | .02 | 92 | 118 | 151 | 213 | 287 | | | | 208 | 208 | 208 | 206 | 206 | 206 | 206 | 204 | | | | | | | | |
| | | 3,500 | | 2.37 | 1.16 | .49 | .16 | .03 | | | | | | | | | 15 | 17 | 20 | 24 | 30 | 36 | 48 | 61 | | | | | | | | |
| | | 5,000 | 4.7 | 3.38 | 1.66 | .70 | .24 | .05 | 97 | 123 | 156 | 218 | 294 | | | | 208 | 208 | 208 | 208 | 206 | 206 | 206 | 204 | | | | | | | | |
| | | 7,500 | | 5.08 | 2.49 | 1.05 | .35 | .07 | | | | | | | | | 16 | 19 | 22 | 25 | 32 | 39 | 50 | 63 | | | | | | | | |
| | | 10,000 | 5.2 | 6.77 | 3.32 | 1.39 | .47 | .09 | 102 | 127 | 160 | 222 | 301 | | | | 210 | 208 | 208 | 208 | 208 | 208 | 206 | 206 | | | | | | | | |
| | | 15,000 | | 10.2 | 4.99 | 2.09 | .71 | .14 | | | | | | | | | 18 | 20 | 24 | 28 | 34 | 41 | 53 | 66 | | | | | | | | |
| | | 20,000 | | | | | | | | | | | | | | | | | | | | | | | | | | | | | | |
| | | 25,000 | | | | | | | | | | | | | | | | | | | | | | | | | | | | | | |
| | | 50,000 | | | | | | | | | | | | | | | | | | | | | | | | | | | | | | |
| | | 75,000 | | | | | | | | | | | | | | | | | | | | | | | | | | | | | | |
| | | 100,000 | | | | | | | | | | | | | | | | | | | | | | | | | | | | | | |
| | | 150,000 | | | | | | | | | | | | | | | | | | | | | | | | | | | | | | |
| 200,000 | | | | | | | | | | | | | | | | | | | | | | | | | | | | | | | | |
| 250,000 | | | | | | | | | | | | | | | | | | | | | | | | | | | | | | | | |

(NOTE) For speeds not shown on the pump hydraulic charts, consult factory.

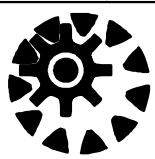

RP

PUMP HYDRAULIC SIZE CHART

SEC. 500

Page 113

January 2010

**190 GPM
640 RPM**

| NOMINAL | | ROTOR TRIM | VISCOSITY (SSU) | N.I.P.R. (PSIA) | FRICTION PIPE LOSS (PSI/FT) (Based on Sch 40 Steel Pipe) | | | | | FULL BYPASS RELIEF VALVE PRESSURE (PSI) | | | | | CAPACITY (GPM) / H.P. REQUIRED | | | | | | | | |
|----------|-----------|------------|-----------------|-----------------|---|--------|------|-----|-----|---|-----|-------------|-----|-----|--------------------------------|-----|-----|-----|-----------------|-----|-----|-----|-----|
| CAP. GPM | SPEED RPM | | | | PIPE DIAMETER | | | | | CRACKING PRESS. (PSI) | | | | | DIFFERENTIAL PRESSURE (PSI) | | | | | | | | |
| | | | | | 2" | 2 1/2" | 3" | 4" | 6" | LOW PRES R/V | | HI PRES R/V | | | MEDIUM DUTY AND HEAVY DUTY | | | | HEAVY DUTY ONLY | | | | |
| | | | | | | | 50 | 75 | 100 | 150 | 200 | 25 | 50 | 75 | 100 | 150 | 200 | 300 | 400 | | | | |
| 190 | 640 | STD | 28 | 3.2 | .24 | .10 | .03 | .01 | - | 60 | 85 | 122 | 180 | | 184 | 181 | 179 | 177 | | | | | |
| | | | 32 | | .26 | .10 | .04 | .01 | - | | | | | | 4.9 | 7.3 | 10 | 13 | | | | | |
| | | | 38 | 3.2 | .27 | .11 | .04 | .01 | - | 63 | 88 | 124 | 183 | | 185 | 182 | 180 | 179 | 174 | | | | |
| | | | 50 | | .30 | .13 | .04 | .01 | - | | | | | | 6.2 | 8.9 | 12 | 15 | 19 | | | | |
| | | | 70 | 3.2 | .33 | .14 | .05 | .01 | - | 67 | 92 | 128 | 187 | 248 | | 187 | 185 | 183 | 178 | 176 | | | |
| | | | 100 | | .37 | .16 | .06 | .02 | - | | | | | | | 7.9 | 10 | 13 | 16 | 21 | 28 | | |
| | | | 150 | 3.2 | .41 | .17 | .06 | .02 | - | 71 | 97 | 132 | 191 | 253 | | 189 | 187 | 186 | 185 | 183 | 181 | 179 | 176 |
| | | | 200 | | .44 | .19 | .07 | .02 | - | | | | | | | 8.9 | 12 | 15 | 18 | 22 | 29 | 39 | 50 |
| | | | 300 | 3.2 | .49 | .21 | .08 | .02 | - | 77 | 102 | 136 | 196 | 260 | | 190 | 189 | 188 | 188 | 187 | 185 | 184 | 183 |
| | | | 500 | | .58 | .25 | .06 | .02 | - | | | | | | | 10 | 13 | 16 | 19 | 24 | 30 | 40 | 50 |
| | | 750 | 3.2 | .45 | .22 | .09 | .03 | .01 | 81 | 107 | 140 | 200 | 266 | | 191 | 191 | 190 | 190 | 189 | 188 | 188 | 187 | |
| | | 1,000 | | .60 | .29 | .12 | .04 | .01 | | | | | | | 11 | 13 | 16 | 19 | 24 | 30 | 41 | 51 | |
| | | 2,000 | 3.5 | 1.19 | .59 | .25 | .08 | .02 | 88 | 114 | 146 | 207 | 276 | | 186 | 185 | 185 | 184 | 183 | 183 | 182 | 180 | |
| | | 3,500 | | 2.09 | 1.03 | .43 | .15 | .03 | | | | | | | 12 | 14 | 18 | 20 | 26 | 31 | 42 | 54 | |
| | | 5,000 | 3.9 | 2.98 | 1.46 | .61 | .21 | .04 | 93 | 119 | 150 | 211 | 281 | | 187 | 186 | 185 | 185 | 184 | 184 | 184 | 181 | |
| | | 7,500 | | 4.47 | 2.20 | .92 | .31 | .06 | | | | | | | 13 | 16 | 19 | 22 | 28 | 33 | 43 | 57 | |
| | | 10,000 | 4.4 | 5.96 | 2.93 | 1.23 | .41 | .08 | 97 | 123 | 154 | 215 | 287 | | 187 | 186 | 186 | 185 | 185 | 185 | 185 | 182 | |
| | | 15,000 | | 8.94 | 4.39 | 1.84 | .62 | .12 | | | | | | | 15 | 18 | 21 | 24 | 30 | 35 | 46 | 60 | |
| | | 20,000 | 5.1 | 11.9 | 5.86 | 2.46 | .83 | .16 | 100 | 126 | 158 | 218 | 292 | | 187 | 187 | 186 | 186 | 186 | 186 | 186 | 183 | |
| | | 25,000 | | 14.9 | 7.32 | 3.07 | 1.04 | .20 | | | | | | | 17 | 20 | 23 | 27 | 32 | 37 | 48 | 63 | |
| 50,000 | | | | | | | | | | | | | | | | | | | | | | | |
| 75,000 | | | | | | | | | | | | | | | | | | | | | | | |
| 100,000 | | | | | | | | | | | | | | | | | | | | | | | |
| 150,000 | | | | | | | | | | | | | | | | | | | | | | | |
| 200,000 | | | | | | | | | | | | | | | | | | | | | | | |
| 250,000 | | | | | | | | | | | | | | | | | | | | | | | |

(NOTE) For speeds not shown on the pump hydraulic charts, consult factory.

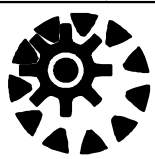

RP

PUMP HYDRAULIC SIZE CHART

SEC. 500

Page 114

January 2010

**155 GPM
520 RPM**

| NOMINAL | | ROTOR TRIM | VISCOSITY (SSU) | N.I.P.R. (PSIA) | FRICTION PIPE LOSS (PSI/FT) <small>(Based on Sch 40 Steel Pipe)</small> | | | | | FULL BYPASS RELIEF VALVE PRESSURE (PSI) | | | | | CAPACITY (GPM) / H.P. REQUIRED | | | | | | | | | | | | | | | | | |
|----------|-----------|------------|-----------------|-----------------|--|--------|-----|-----|-----|---|-----|-------------|-----|-----|--------------------------------|-----|-----|-----|-----------------|-----|-----|-----|--|--|--|--|--|--|--|--|--|--|
| CAP. GPM | SPEED RPM | | | | PIPE DIAMETER | | | | | CRACKING PRESS. (PSI) | | | | | DIFFERENTIAL PRESSURE (PSI) | | | | | | | | | | | | | | | | | |
| | | | | | 2" | 2 1/2" | 3" | 4" | 6" | LOW PRES R/V | | HI PRES R/V | | | MEDIUM DUTY AND HEAVY DUTY | | | | HEAVY DUTY ONLY | | | | | | | | | | | | | |
| | | | | | | | | | | | | | | | | | | | | | | | | | | | | | | | | |
| 155 | 520 | STD | 28 | 2.3 | .16 | .07 | .02 | .01 | - | 57 | 84 | 120 | 178 | | 148 | 145 | 143 | 141 | | | | | | | | | | | | | | |
| | | | 32 | | .17 | .07 | .02 | .01 | - | | | | | | 3.3 | 5.3 | 7.9 | 10 | | | | | | | | | | | | | | |
| | | | 38 | 2.3 | .19 | .08 | .03 | .01 | - | 60 | 86 | 122 | 180 | | 149 | 147 | 145 | 143 | 138 | | | | | | | | | | | | | |
| | | | 50 | | .20 | .09 | .03 | .01 | - | | | | | | 4.6 | 6.7 | 9.1 | 11 | 16 | | | | | | | | | | | | | |
| | | | 70 | 2.3 | .23 | .10 | .03 | .01 | - | 63 | 89 | 124 | 183 | 242 | 151 | 149 | 147 | 146 | 143 | 140 | | | | | | | | | | | | |
| | | | 100 | | .25 | .11 | .04 | .01 | - | | | | | | 5.9 | 7.9 | 10 | 12 | 17 | 22 | | | | | | | | | | | | |
| | | | 150 | 2.3 | .28 | .12 | .04 | .01 | - | 66 | 93 | 127 | 186 | 246 | 153 | 152 | 150 | 150 | 148 | 146 | 144 | 141 | | | | | | | | | | |
| | | | 200 | | .31 | .13 | .05 | .01 | - | | | | | | 6.7 | 8.8 | 11 | 13 | 18 | 22 | 31 | 40 | | | | | | | | | | |
| | | | 300 | 2.3 | .35 | .15 | .05 | .01 | - | 72 | 98 | 131 | 190 | 251 | 154 | 153 | 153 | 152 | 151 | 150 | 149 | 148 | | | | | | | | | | |
| | | | 500 | | .41 | .12 | .05 | .02 | - | | | | | | 7.6 | 9.8 | 12 | 14 | 18 | 23 | 32 | 41 | | | | | | | | | | |
| | | 750 | 2.3 | .36 | .18 | .07 | .03 | - | 75 | 101 | 134 | 193 | 254 | 155 | 155 | 154 | 154 | 153 | 153 | 152 | 152 | | | | | | | | | | | |
| | | 1,000 | | .48 | .24 | .10 | .03 | .01 | | | | | | 7.8 | 10 | 12 | 14 | 19 | 23 | 33 | 41 | | | | | | | | | | | |
| | | 2,000 | 2.9 | .97 | .47 | .20 | .07 | .01 | 82 | 110 | 139 | 199 | 260 | 152 | 151 | 151 | 150 | 149 | 149 | 148 | 146 | | | | | | | | | | | |
| | | 3,500 | | 1.69 | .83 | .35 | .12 | .02 | | | | | | 8.6 | 11 | 13 | 16 | 20 | 24 | 34 | 42 | | | | | | | | | | | |
| | | 5,000 | 3.3 | 2.42 | 1.19 | .50 | .17 | .03 | 86 | 112 | 142 | 202 | 264 | 153 | 152 | 152 | 151 | 151 | 150 | 149 | 148 | | | | | | | | | | | |
| | | 7,500 | | 3.63 | 1.78 | .75 | .25 | .05 | | | | | | 11 | 13 | 14 | 18 | 23 | 27 | 36 | 44 | | | | | | | | | | | |
| | | 10,000 | 3.8 | 4.83 | 2.37 | 1.00 | .34 | .07 | 89 | 115 | 145 | 205 | 268 | 154 | 153 | 153 | 152 | 152 | 151 | 151 | 149 | | | | | | | | | | | |
| | | 15,000 | | 7.25 | 3.56 | 1.49 | .50 | .10 | | | | | | 14 | 16 | 19 | 20 | 25 | 29 | 38 | 47 | | | | | | | | | | | |
| | | 20,000 | 4.3 | 9.67 | 4.75 | 1.99 | .67 | .13 | 93 | 118 | 148 | 207 | 272 | 155 | 154 | 154 | 153 | 153 | 152 | 152 | 151 | | | | | | | | | | | |
| | | 25,000 | | 12.1 | 5.94 | 2.49 | .84 | .16 | | | | | | 16 | 18 | 21 | 23 | 28 | 32 | 41 | 49 | | | | | | | | | | | |
| 50,000 | 6.1 | 24.2 | 11.9 | 4.98 | 1.68 | .33 | 98 | 124 | 151 | 212 | 276 | 155 | 154 | 154 | 153 | 153 | 152 | 152 | 151 | | | | | | | | | | | | | |
| 75,000 | | 36.3 | 17.8 | 7.47 | 2.52 | .49 | | | | | | 22 | 24 | 27 | 30 | 34 | 39 | 48 | 57 | | | | | | | | | | | | | |
| 100,000 | | | | | | | | | | | | | | | | | | | | | | | | | | | | | | | | |
| 150,000 | | | | | | | | | | | | | | | | | | | | | | | | | | | | | | | | |
| 200,000 | | | | | | | | | | | | | | | | | | | | | | | | | | | | | | | | |
| 250,000 | | | | | | | | | | | | | | | | | | | | | | | | | | | | | | | | |

(NOTE) For speeds not shown on the pump hydraulic charts, consult factory.

